

# Yale Energy Studies

SOCIETY • TECHNOLOGY • ENVIRONMENT

*Class of 2023 Yale Energy Scholars*

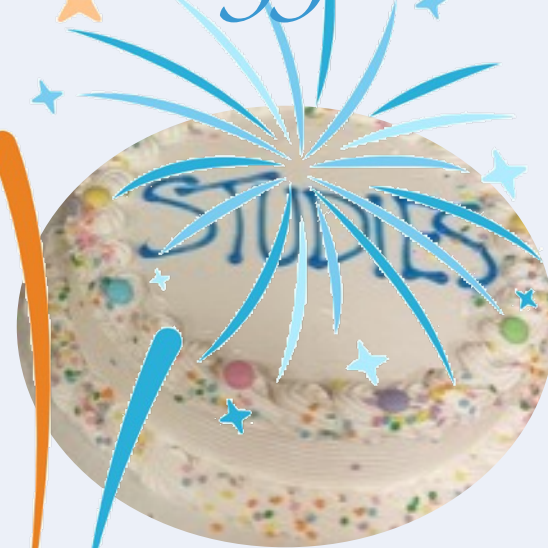

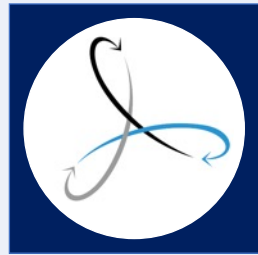

**Yale**

ENERGY STUDIES

*Multidisciplinary Academic Program*





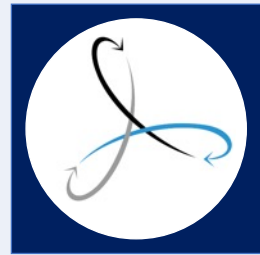

**Yale**  
ENERGY STUDIES  
*Interdisciplinary Certificate Program*





## Class of 2023 Yale Energy Scholars

30 Graduating with Energy Studies Certificates in May 2023  
(2 in the Class of 2023 delaying until the Fall or next Spring)

40 B.A./B.S. Degrees and 1 M.S. Degree in the Class of 2023 in 16 Different Majors

Applied Mathematics (1); Applied Physics (2); **Earth & Planetary Sciences (5)**; **Economics (9)**;  
Engineering Science-Chemical (2); **Engineering Science-Mechanical (6)**; Engineering Science-Electrical (1);  
Environmental Engineering (2); **Environmental Studies (3)**; Ethics, Politics, and Economics (1); Film and Media Studies (1);  
Global Affairs (1); Physics (Intensive) (2); Political Science (1); Statistics and Data Science (2); Urban Studies (1)



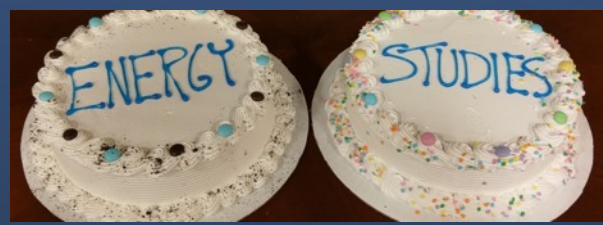
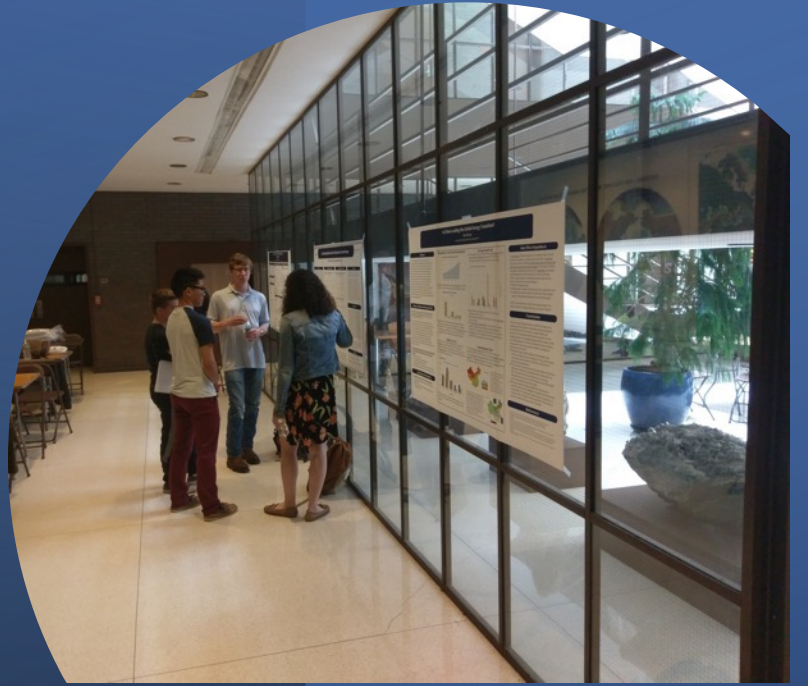





DECEMBER 2021





DECEMBER 2021





FEBRUARY 2023



# U.S. Department of Energy Announces Winners of the 2023 Hydropower and Marine Energy Collegiate Competitions

MAY 10, 2023

The winners of the 2023 HCC are:

- First place: Endicott College
- **Second place: Yale University**
- Third place: Northern Arizona University

Individual category winners are:

- Best Poster: Texas Tech University
- Case Study Contest: Endicott College
- **Connection Creation Contest: Yale University**



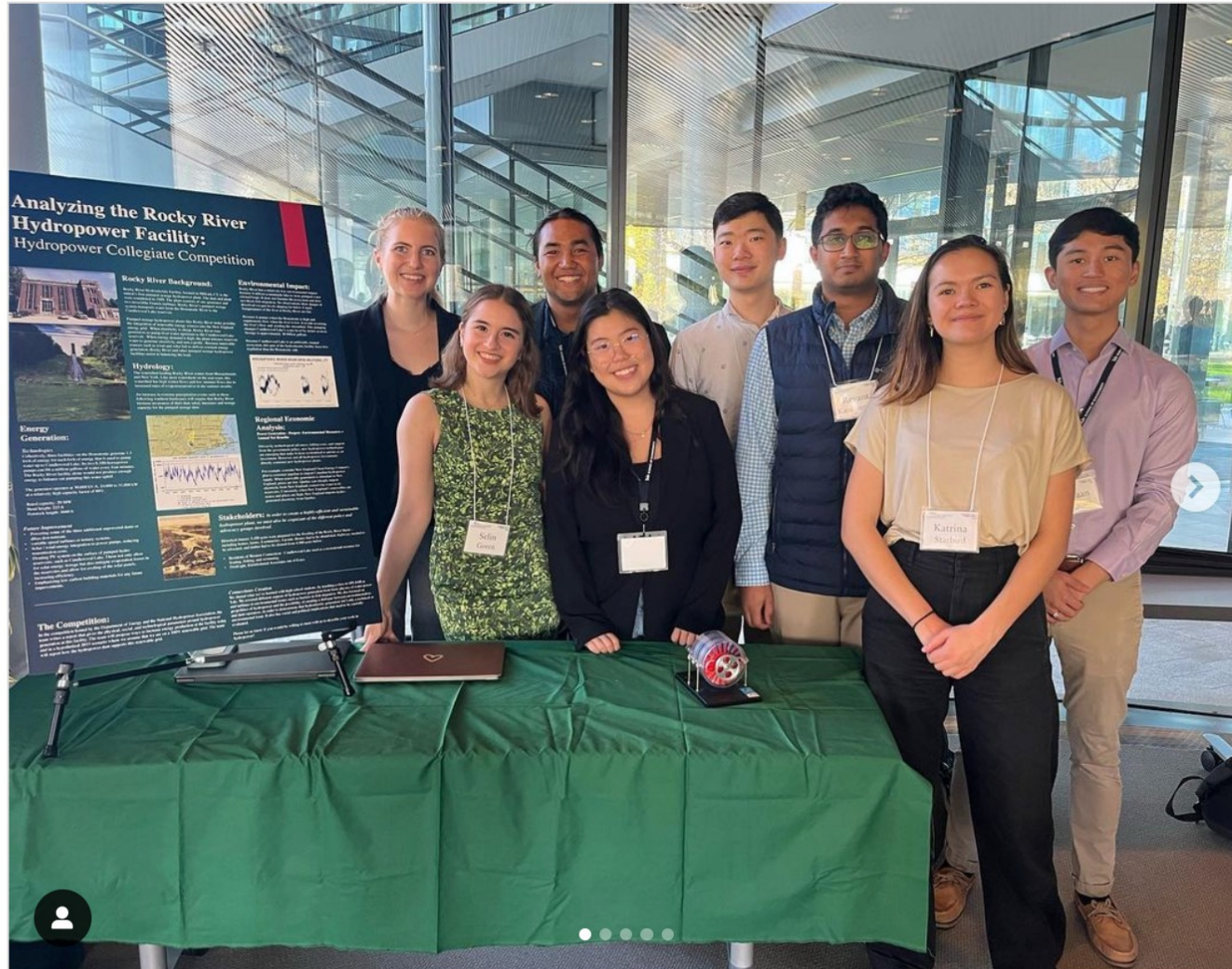

yaleevst • Follow



The Yale team won 2nd place in the first annual Hydropower Collegiate Competition (HCC) organized by the Department of Energy! 💧⚡👏

The team consisted of Energy Studies students Katrina Starbird (EPS'23), Neal Ma (Physics'23), Shayaan Subzwari (Physics'23), Maddie Bartels (EPS'23.5), Selin Gören (EVST'24), Ruth Lee (Undeclared'25) and was advised by Michael Oristaglio. The team



80 likes

6 DAYS AGO

Log in to like or comment.

Yale HCC 2023 Team Creating Connections at the Fall 2022 Conference of the Yale Planetary Solutions Initiative





Energy Studies Seniors on the Yale HCC 2023 Team  
 Katrina Starbird (EPS), Neal Ma (Physics), Maddie Bartels (EPS), Shayaan Subzwari (Physics)



# Panorama of Rocky River Hydropower Station, New Milford, Connecticut

*Energy Studies and EPS 275 Field Trip, 17 February 2023*





Canal from Candlewood Lake to Penstock →

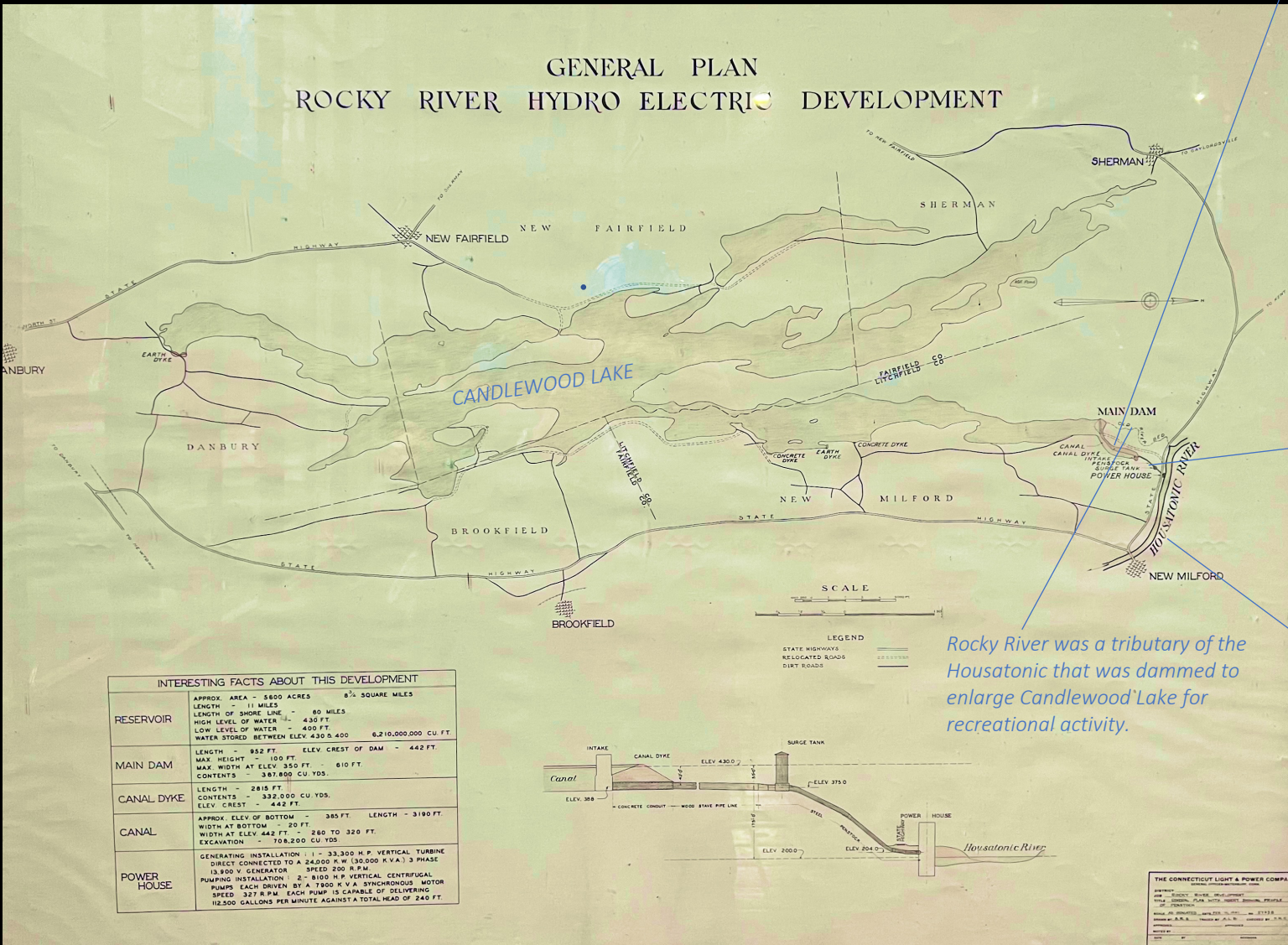

Rocky River was a tributary of the Housatonic that was dammed to enlarge Candlewood Lake for recreational activity.



→  
Housatonic River  
(behind station)





*Canal leading from Candlewood Lake*



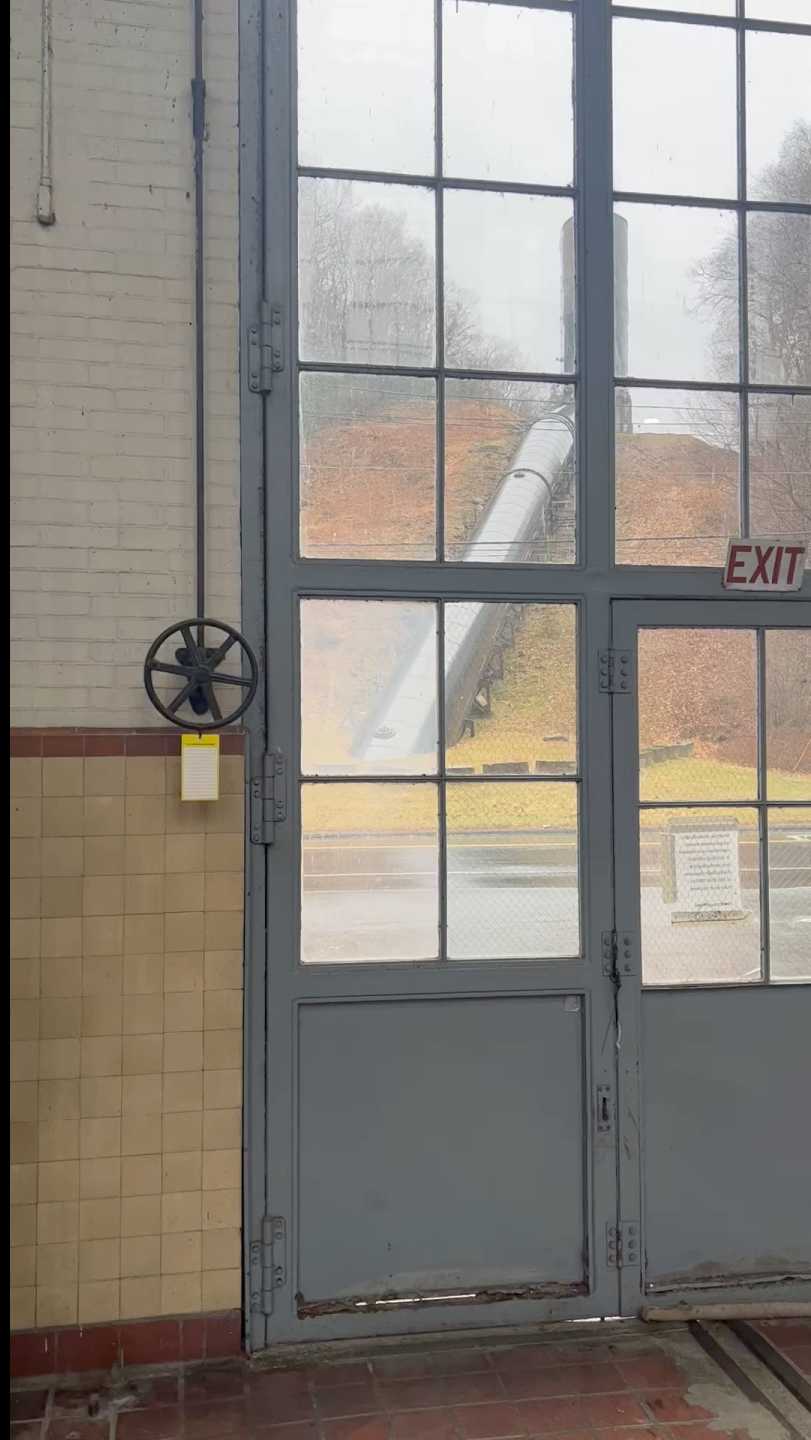

*View of Penstock from Station →*



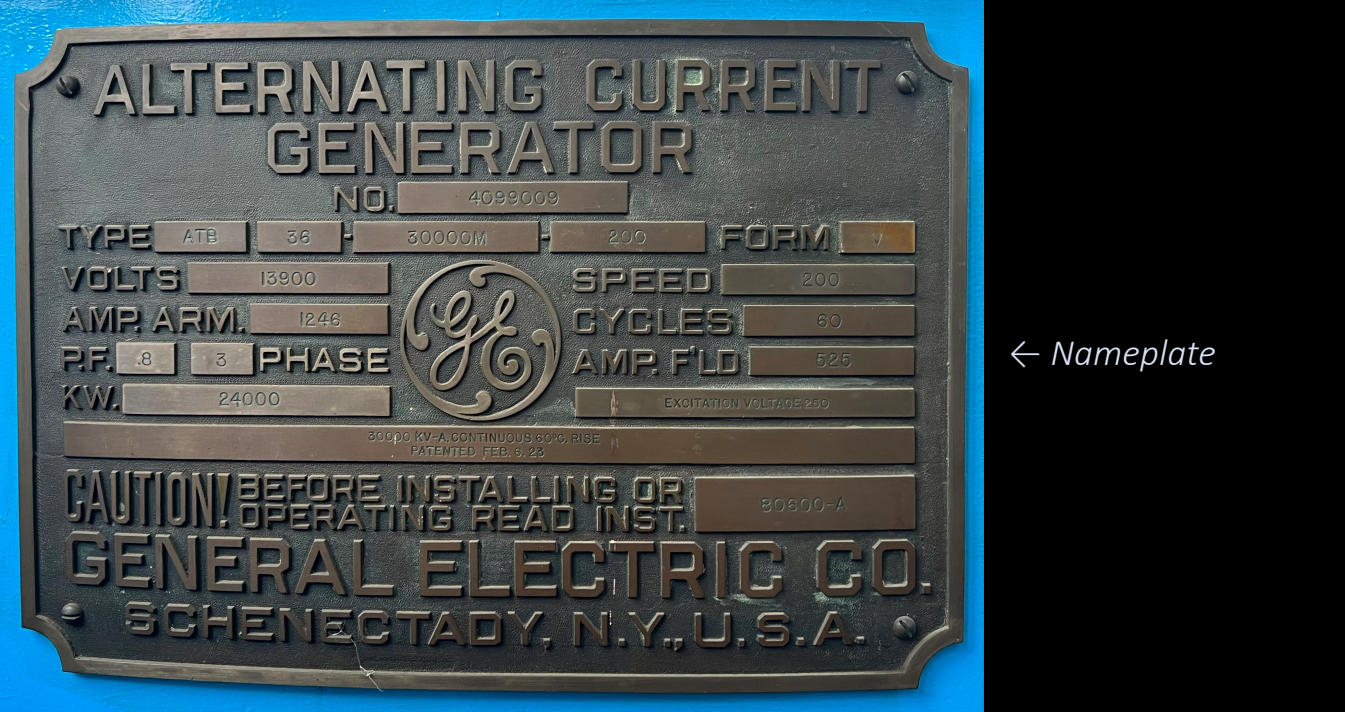

← Nameplate

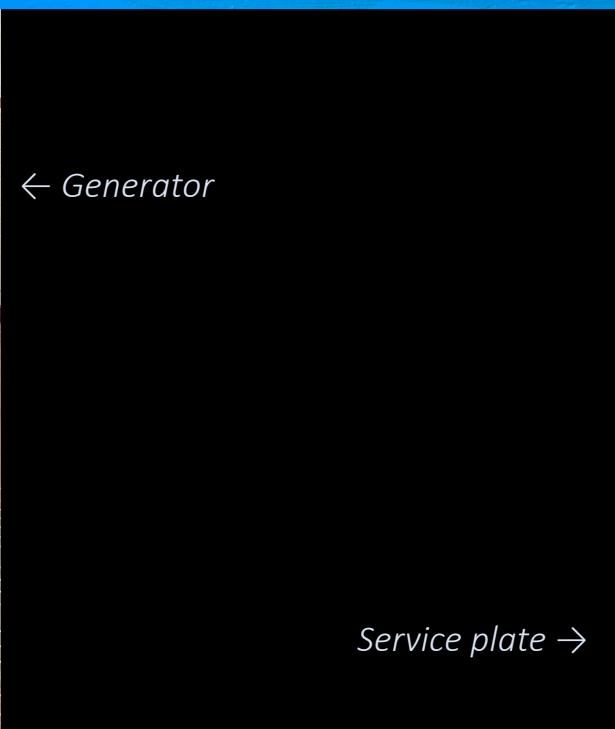

← Generator



Service plate →

# ALTERNATING CURRENT GENERATOR

NO. 4099009

TYPE	ATB	36	30000M	200	FORM	V
VOLTS	13900		SPEED		200	
AMP. ARM.	1246		CYCLES		60	
P.F.	.8	3	PHASE		AMP. FLD 525	
KW.	24000		EXCITATION VOLTAGE		250	



30000 KV-A. CONTINUOUS 60% RISE  
PATENTED FEB. 6, 25

CAUTION! BEFORE INSTALLING OR OPERATING READ INST. 30600-A

## GENERAL ELECTRIC CO.

SCHENECTADY, N.Y., U.S.A.

GEN ROTOR 72 SHAFT  
265,600 LBS  
WEIGHED ON 6/25/81



**WOOD GROUP GENERATOR SERVICES, INC.**  
FARMINGTON, NEW MEXICO

RATED KVA - 36,000	POWER FACTOR - 0.90
RATED VOLTAGE - 13900	RATED CURRENT - 1495
RPM - 200	PHASE - 3 HERTZ - 60
EXCITATION VOLTS - 250	EXCITATION AMPERES - 525
RATED STATOR TEMPERATURE RISE BY RTD - 60° C	CONNECTION - WYE
RATED FIELD TEMPERATURE RISE BY RES. - 60° C	ROTOR INSULATION CLASS - 155° C
STATOR INSULATION CLASS - 155° C	SERIAL NUMBER: 4099009

RESTACK & REWIND REHABILITATION MAY 2005  
CONTRACT No PO-02218416





Lower Floor of Station

↓ Francis turbine (24 MW)

←  
1 of 2 pumps, which  
also run as generators  
adding another 5MW  
of power capacity







*Explanation of how pumping is managed →*





**STOP!**

DO NOT ENTER CONTROL ROOM UNLESS ABSOLUTELY NECESSARY

CONTROL ROOM IS OFF LIMITS TO ANYONE NOT SPECIFICALLY  
TASKED TO ENTER FOR A JOB ASSIGNMENT

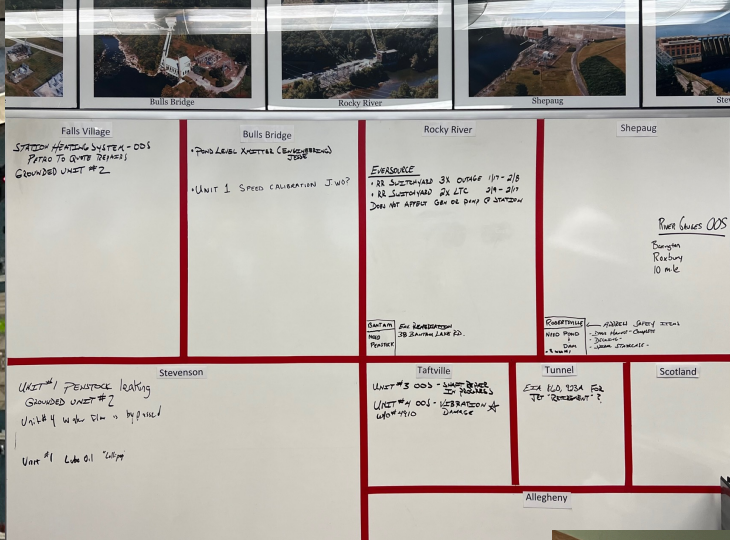

Bid Office

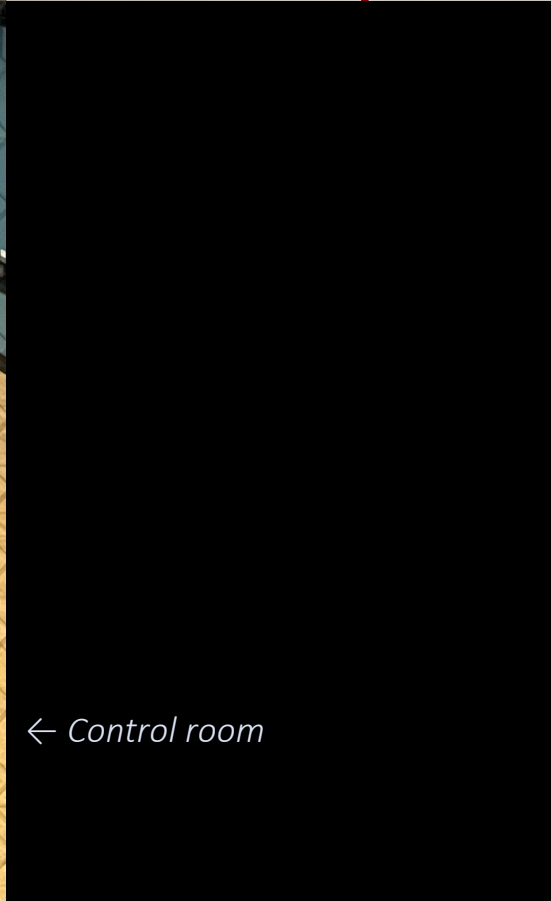





*Explanation of operations*





[electricamerica.org](http://electricamerica.org)





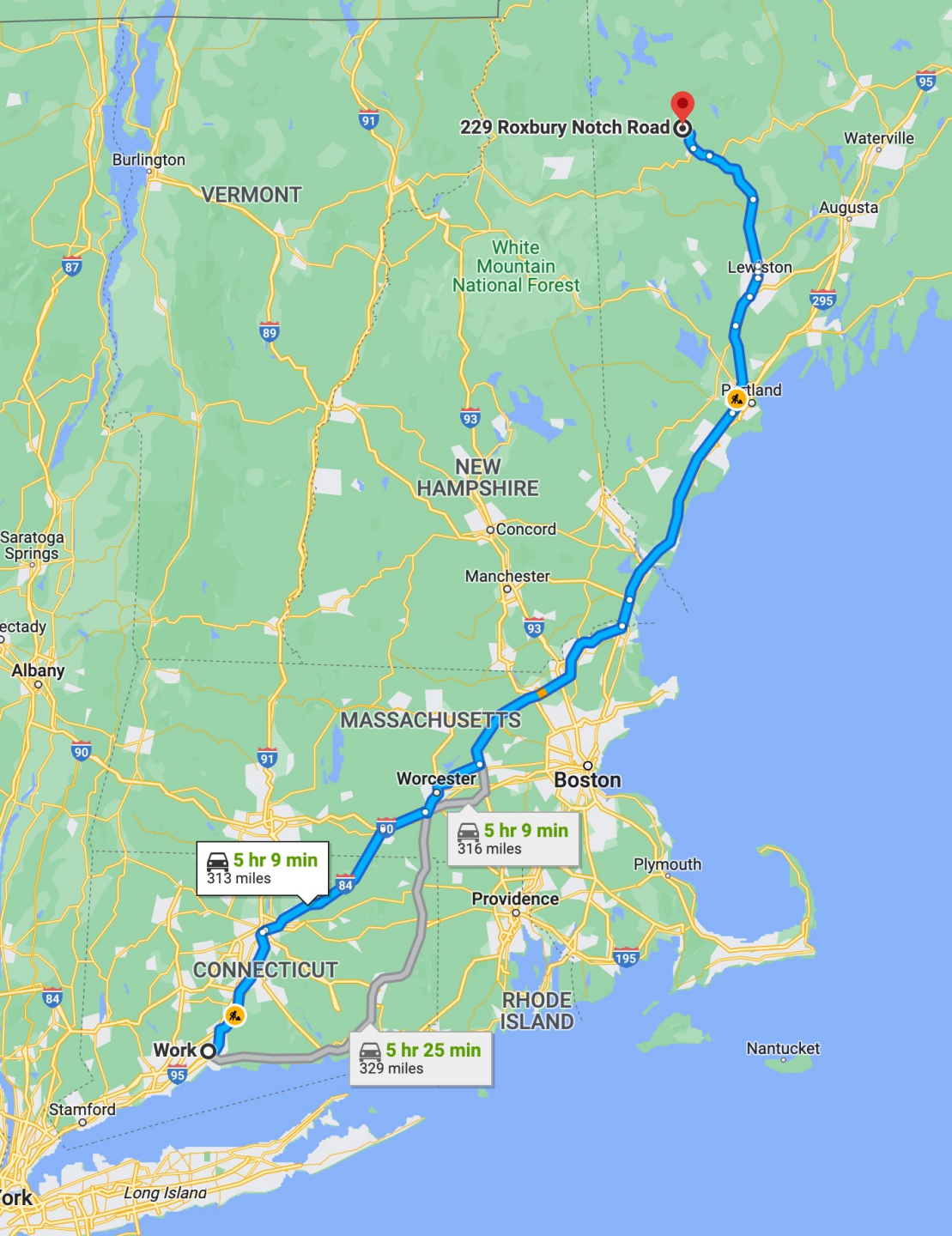

*Energy Studies Field Trip to Yale Record Hill Wind Farm in Maine*

**50.6 MW of clean renewable energy**

Record Hill Wind has built an innovative wind energy farm in Roxbury, Maine. Consisting of twenty-two Siemens 93 2.3 MW turbines along a four mile ridgeline, the project has a nameplate capacity of 50.6 MW. RHW generates power for the community while creating and preserving jobs in rural Maine.











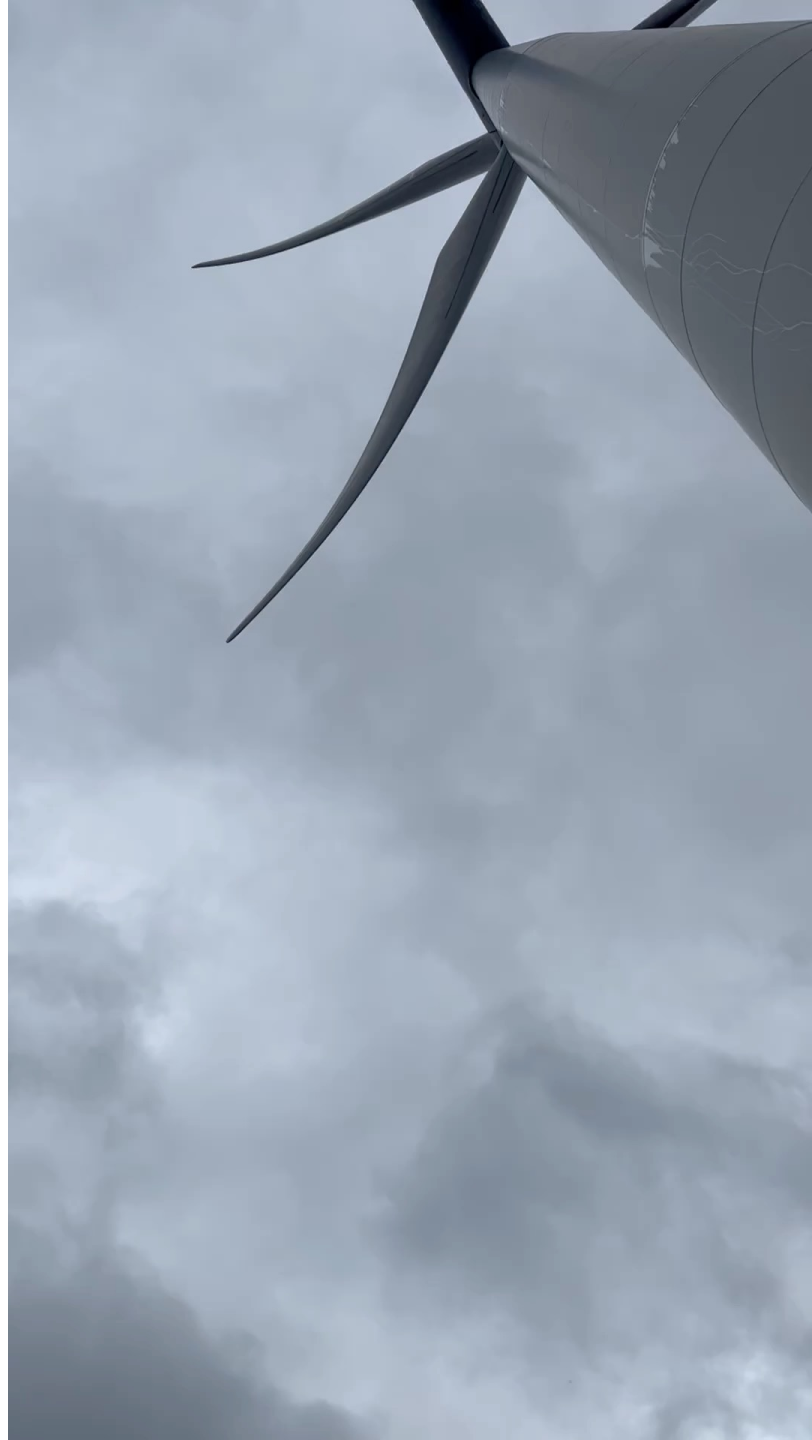







# The Criticism of Nordhaus's Social Cost of Carbon

## Nikola Bakoc '23

Trumbull | Engineering Science-Mechanical;  
Engineering Science-Electrical

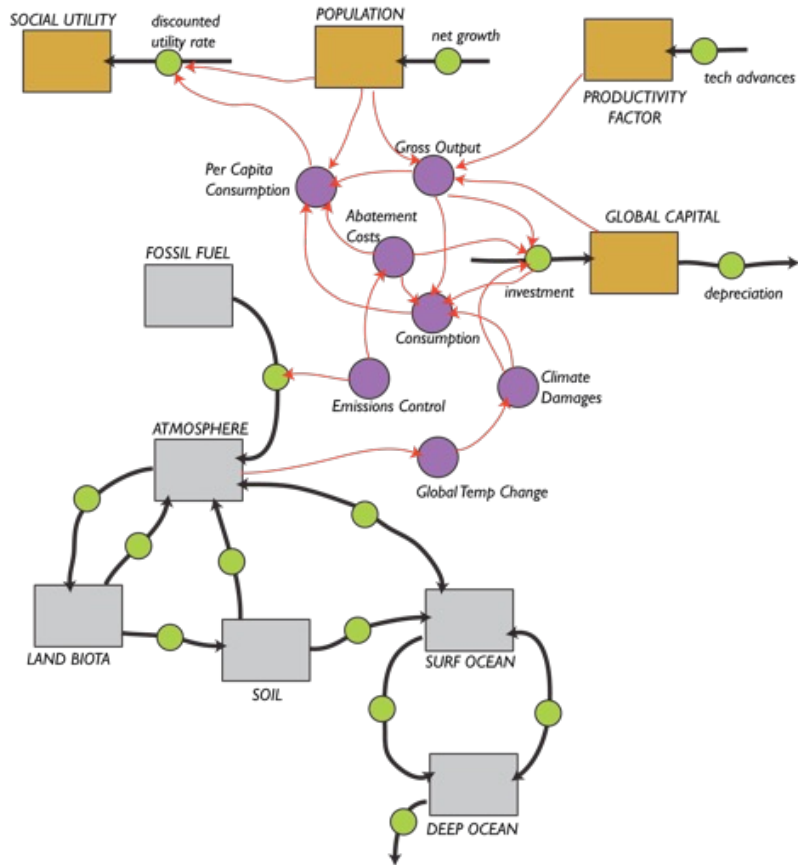

↑ Schematic of Dynamic Integrated Climate-Economy Model (DICE).

William D. Nordhaus, a distinguished economist, is credited with pioneering the term "social cost of carbon" (SCC), a concept that earned him the prestigious Nobel Prize. Despite his notable contributions to the field of environmental economics, Nordhaus has faced significant criticism regarding his work. In this context, my investigation aims to evaluate the validity of these criticisms and examine Nordhaus's response to them...

To summarize, Nordhaus receives critiques on this pioneering work on the SCC. These are about his usage of CBA (in regard to fat tails tipping points and discount rates) and the moral argument. Nordhaus mostly has a decent and mature response to all of the criticism but promotes further discussion. Overall, in my opinion, I believe that Nordhaus's work is revolutionary. It changed the way we think about the climate. But we need to keep improving the way we think even further. With more evidence of high-impact events we need to adjust and rethink our current estimates. I disagree that we should settle at the 3.5 degrees C increase as that would likely have devastating consequences.

The Social Cost of Carbon represents the economic damage caused by an additional ton of CO<sub>2</sub> emissions (or, more succinctly, carbon) or its equivalent (Nordhaus, 2013, *The Climate Casino*) →

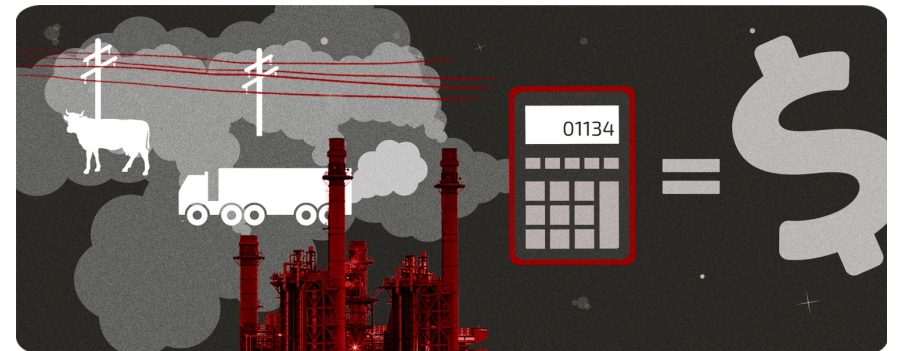



# Technical Costing Configuration of Water Treatment System

## Michelle Barsukov '23

Timothy Dwight | Engineering Science-Chemical; Economics

In the summer of 2021, I was an applications engineering intern at Culligan International. Culligan is a water technologies company headquartered in Rosemont, Illinois. It was founded in 1936 with a mission to provide cleaner, more sustainable, and better-tasting water (Culligan International, 2020). The company operates in four markets: residential, retail, commercial, and industrial. Retail products are sold in stores or online catalogues and are typically consumer-targeted, such as home faucet filters and water pitchers. Residential, commercial, and industrial sales occur by way of direct end-user sales or Culligan franchises, which form a network of dealers and licensees in about 100 countries. In addition to direct sales, dealers perform maintenance, installation, delivery, and other services for customers.

The applications engineering department is the gateway between sales and project engineering within Culligan's Commercial and Industrial (C&I) branch, located in Libertyville, Illinois. Applications engineers communicate with end user customers and Culligan dealers in order to define project scope, collect discovery technical data, and quote systems. ...

My role throughout my internship was to develop tools in order to bolster the applications engineers' operations. In addition to writing engineering specifications, performing industry research, and creating technical brochures, my main project for the summer centered around the Costing Configurator ("the Configurator"). This will be discussed in Section II. Since my work focused primarily on water softeners, depth filters, greensand filters, and carbon filters, I will first define each type of water treatment.

 <b>SEP2STD System Dealer Configurator</b>		PURCHASE ORDER #		<div style="background-color: #4CAF50; color: white; padding: 10px; border-radius: 15px; text-align: center;">             TO ORDER EQUIPMENT PLEASE FILL OUT PO FORM AND EMAIL THIS DOCUMENT TO C&amp;I.Solutions@Culligan.com (Save the file yourself and attach to the email)           </div>	
		SPECIAL INSTRUCTIONS			
DEALER CONTACT PERSON		SHIP-TO:			
CULLIGAN DEALERSHIP #	1000	STREET ADDRESS LINE 1	SEP-STD Configurator Version 4.0		
DEALERSHIP NAME	Culligan Water of The Triangle	STREET ADDRESS LINE 2	TANKS 72" IN DIAMETER ARE AVAILABLE ONLY IN SINGLE CONFIGURATIONS AS HI-FLO W/ WITH STAINLESS STEEL HARNESS AND CAST-IRON BUTTERFLY VALVES. THESE CONFIGURATION OUTPUTS ARE ESTIMATES, CONFIRM WITH C&I SOLUTIONS.		
DEALER TYPE	US Dealer	CITY	Configurator Run Date		
CONTACT EMAIL		STATE/PROVINCE	8/9/2021		
CONTACT PHONE		ZIP/POSTAL			
CONFIGURABLE ELEMENTS		SELECT OPTION FROM DROPDOWN LIST IN EACH YELLOW CELL (FOR BEST RESULTS, GO FROM TOP TO BOTTOM)	MAN'F CONFIGURATION		
Valve Type & Size		Hi-Flo w/ CPVC Harness and Cast Iron Butterfly Valves	HBCP	Clear Dealer Data	
Water Treatment Type		Softener	S		
Number of Tanks		Duplex Progressive	2P	Clear Selections	
Skid Type		Welded & Painted Carbon Steel Skid			
Tank Material of Construction		ASME Code Stamped	C		
Tank Size: Diameter X Height (Softening Capacity)		54in x 60In (1500 Kgr, 3" valves)	543		
Controller Type		Standard GBE (Valve Mounted)	G		
Interconnecting and/or Face-Pipe Material & Joint Construction		Sch. 80 CPVC with Glued Fitting Connections and Isolation Valves	CP		
Direction of flow through system		Inlet Connection on Left Side, Outlet and Drain on the Right	DR		
Add Efficiency Improving Accessories		Aqua-Sensor	A		
Select Brine System		39" x 48" Tank with 1" Valve	Enter # of Brine Tanks Here >>>	1.0	
Top Level Configuration Model Number	Advertised Lead Time	Estimated Dimensions (W x D x H)	Estimated Operating Weight +/- 10% (lbs)	Estimated Shipping Weight +/- 10% (lbs)	US Dealer Sales Price Total (USD)

↑ Dealer-Facing Configurator Menu. Note that in this and other Figures from the Configurator, all dollar values and dealer numbers are proprietary and redacted.



# Small-Scale Production of Hydrogen Using Bulk Metallic Glasses

## Riis Card '23

Grace Hopper | Mechanical Engineering; Film and Media Studies

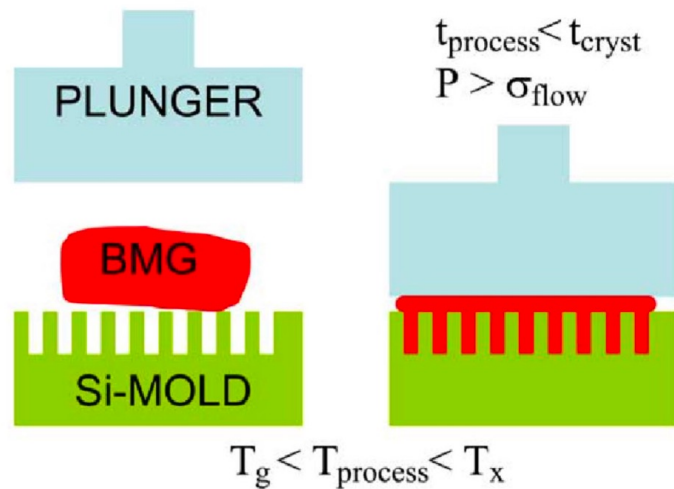

↑ Schematic of two-step process for thermoplastic forming in manufacturing of bulk metallic glass samples for use in electrolysis of water for form hydrogen.

From left to right: Scanning electron microscope (SEM) images of 40 nm, 160 nm, and 250 nm Pt bulk metallic glass samples for use in water electrolysis →

Hydrogen as an energy source has some promising characteristics for rollout across the world but is hampered by overwhelming infrastructure requirements; when stored either as liquid or gas, hydrogen easily leaks from its container, raising costs and posing safety risks due to its highly explosive nature. Instead of relying on widespread, leak-resistant infrastructure for hydrogen delivery, it may be more practical to produce hydrogen at its deployment site for use in distributed generation systems and in vehicles. Currently, hydrogen is mainly produced through chemical reaction involving natural gas at large-scale facilities. It may be possible for hydrogen to be produced at a much smaller scale by means of the hydrogen evolution reaction.

Hydrogen reduction, a major step in this reaction, can be achieved by catalysis involving noble metals, especially platinum. Here, we utilize a  $Pt_{57.5}Cu_{14.7}Ni_{5.3}P_{22.5}$  bulk metallic glass in a 0.5 M  $H_2SO_4$  electrolyte to determine its viability as a catalyst for hydrogen production and then move towards morphologies that greatly increase catalyst surface area, which theoretically permits an exceptionally higher rate of production. We discover that this bulk metallic glass is viable for hydrogen reduction but requires further testing to best characterize its capabilities and eventually tune.

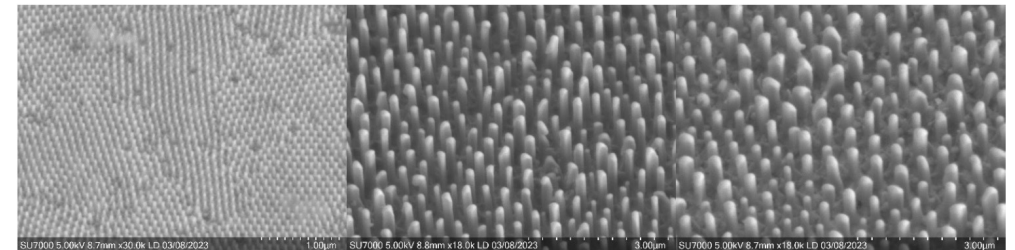



# A Roadmap for Lifecycle Refrigerant Management at Yale University

## Tilden Chao '23

Ezra Stiles | Economics

Refrigerant Emissions Sources (2021)		
<i>all in metric tons CO<sub>2</sub>e</i>		
Accounted	GWP-100	GWP-20
Buildings (Non-Plant)	2,076.14	4,650.55
Power Plant Chillers (HFCs)	1,297.27	2,905.88
Fleet Vehicles	235.09	526.61
Total Accounted	3,608.50	8,083.04
Unaccounted	GWP-100	GWP-20
Dining Refrigeration	435.28	667.04
Additional Building Cooling	1,001.86	2,112.04
Power Plant Chillers (HCFCs)	411.36	1,172.73
Laboratories	2,176.48	3,550.64
Total Unaccounted	4,024.98	7,502.44
<b>Total (Acc. + Unacc.)</b>	<b>7,633.48</b>	<b>15,585.48</b>

↑ Inventory data produced by this study showing dramatic underreporting of HFC emissions

Reducing fugitive emissions of refrigerant gases such as hydrochlorofluorocarbons (HCFCs) and hydrofluorocarbons (HFCs) will be a significant challenge in reaching Yale's net zero emissions commitment. Although these gases currently account for only 1.6 percent of the University's reported scope 1 emissions, deficiencies in past greenhouse gas inventories have led to an underestimate of campus refrigerant emissions. Using data from a campus-wide refrigerant inventory that I conducted between 2021 and 2022, I find that refrigerant emissions truly account for at least 3.3 percent of the University's scope 1 emissions. These emissions are growing in magnitude and as a proportion of Yale's greenhouse gas inventory as the University moves to decarbonize buildings with heat pumps and variable refrigerant flow systems. I propose a five-component strategy to help Yale reduce its refrigerant emissions along its pathway to net zero.

Yale Reported Scope 1 Emissions (2021)					
<i>all in metric tons CO<sub>2</sub>e</i>	Total CO <sub>2</sub> e	CO <sub>2</sub>	CH <sub>4</sub>	N <sub>2</sub> O	HFC
Stationary Combustion	222,632.88	222,391.35	107.46	134.07	-
Mobile Combustion (Fleet)	2,371.28	2,354.40	3.35	13.53	-
Fugitive Emissions (HFCs)	3,608.50	-	-	-	3,608.50
Total	228,612.66	224,745.75	110.81	147.60	3,608.50

↑ 2021 Scope 1 report by Yale showing HFCs as a small Overall Contributor to Yale Emissions



# Housing Constraints and Household Energy Consumption in the United States

Noah Friedlander '23

Pauli Murray | Economics; Global Affairs

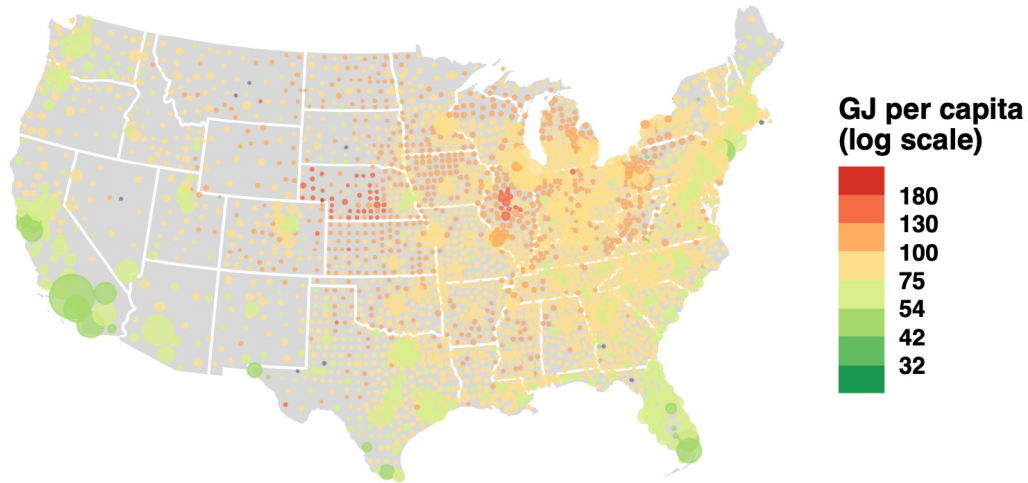

↑ Residential and light-duty vehicle energy consumption, 2020

Excessively restrictive land use and housing construction regulatory environments in certain U.S. metropolitan areas – especially the New York City area and San Francisco Bay Area – have been shown to result in the geographic “misallocation” of workers and people to less productive and resource-rich areas. I hypothesize that these policies also increase national household energy demand, all else equal. To test this hypothesis, I construct a counterfactual scenario in which these restrictive policies are not in place. My baseline results suggest that these policies may be responsible for on the order of 8% of U.S. household energy demand, including on the order of 13.5% of light duty vehicle energy consumption. This suggests that these restrictive land use and housing construction regulations may contribute non-negligibly to U.S. fossil fuel emissions.

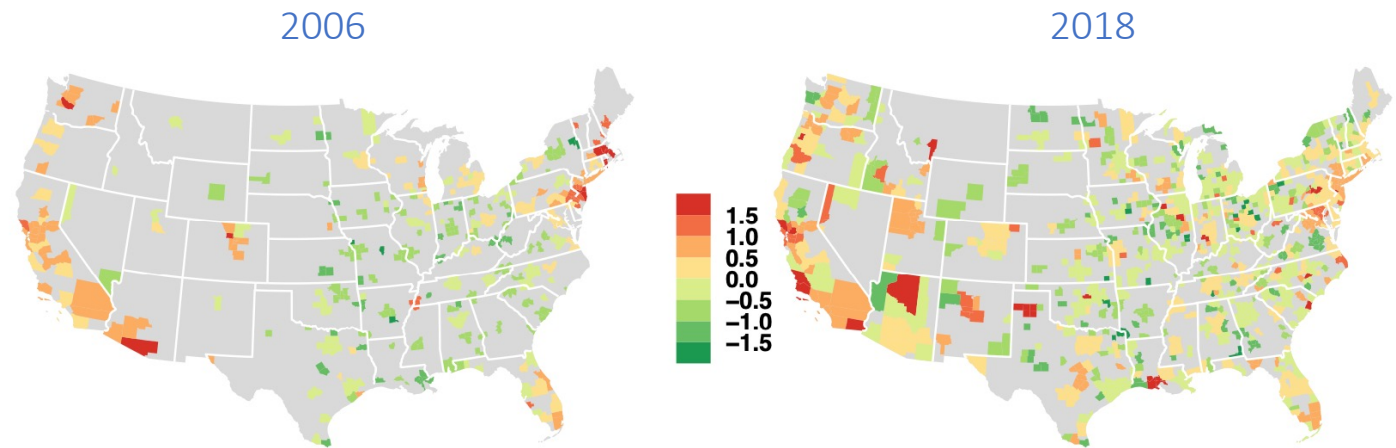

↑ Wharton Residential Land Use Regulatory Index at the Metropolitan Statistical Area



# The Locational Suitability of In-Stream Hydrokinetic Turbines: A Regional Assessment

Liam Galloway '23

Berkeley | Environmental Studies

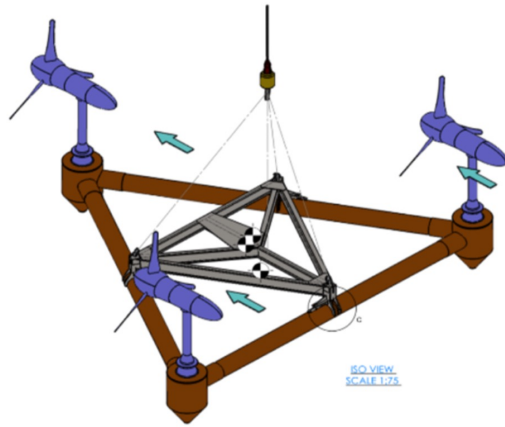

↑ Verdant Power Tri-Mount Hydrokinetic Turbine Design

Threatened by climate change, global energy systems need to align with the clean energy transition. The current portfolio relies heavily on carbon-based fossil fuels and lacks renewable options. Embracing new forms such as in-stream tidal energy is crucial. However, tidal energy faces limitations due to the scarcity of suitable locations.

This thesis examines nine East Coast locations in the United States to assess their power production potential. To determine suitability, the model considers tidal variation and discharge data and calculates two variables at half-hour intervals from flow records: hydrologic flow ( $U_h$ ) and upriver tidal wave ( $U_t$ ). Combining these values yields water velocity, which determines power output using the hydrokinetic turbine power equation.

Out of the nine locations, seven were able to generate power. However, only 5 produced over 1 megawatt hour per week, sufficient to meet the energy needs of 750 homes simultaneously. This assessment expands the range of renewable energy options available for the global energy portfolio. In conclusion, the urgency to combat climate change demands a shift towards clean energy. In-stream tidal energy presents a promising alternative. By assessing and identifying suitable locations, this study contributes to expanding the utilization of tidal energy, enhancing the diversification of renewable energy sources.

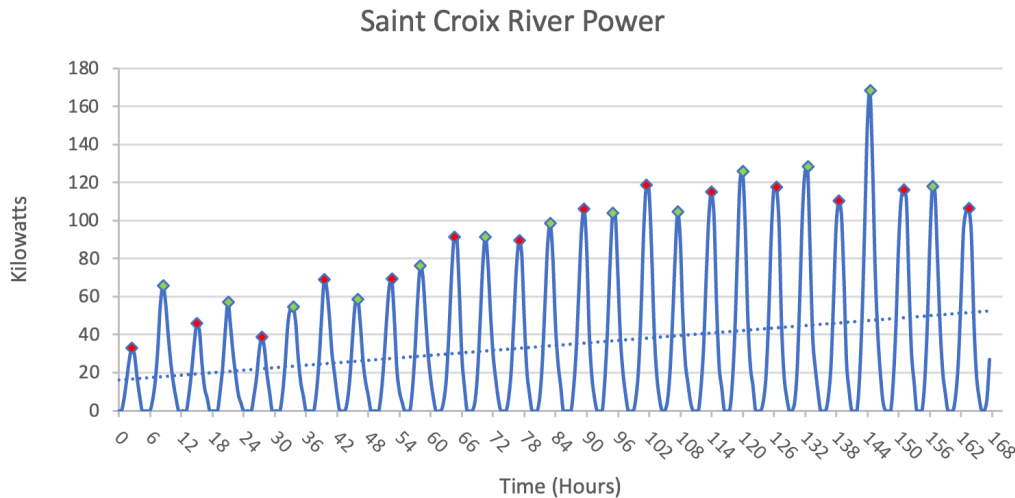

← Estimate of hydrokinetic power available on the Saint Croix River near the US-Canadian border in Maine, obtained from tidal flow records.



# Designing Plasma Electrochemical Methods for Enhanced $N_2$ and $CO_2$ Conversion

## Saachi Grewal '23

Pierson | Applied Physics

SEAS Dean Jeffrey Brock announced Saachi Grewal, an Applied Physics B.S. major with a certificate in Energy Studies, as the winner of the Henry Prentiss Becton Senior Prize, awarded by the Dean of Engineering to a senior for rewarding and encouraging outstanding student performance. Grewal was the School's flag bearer at Yale College Commencement Ceremony. → [- seas.yale.edu](https://seas.yale.edu)

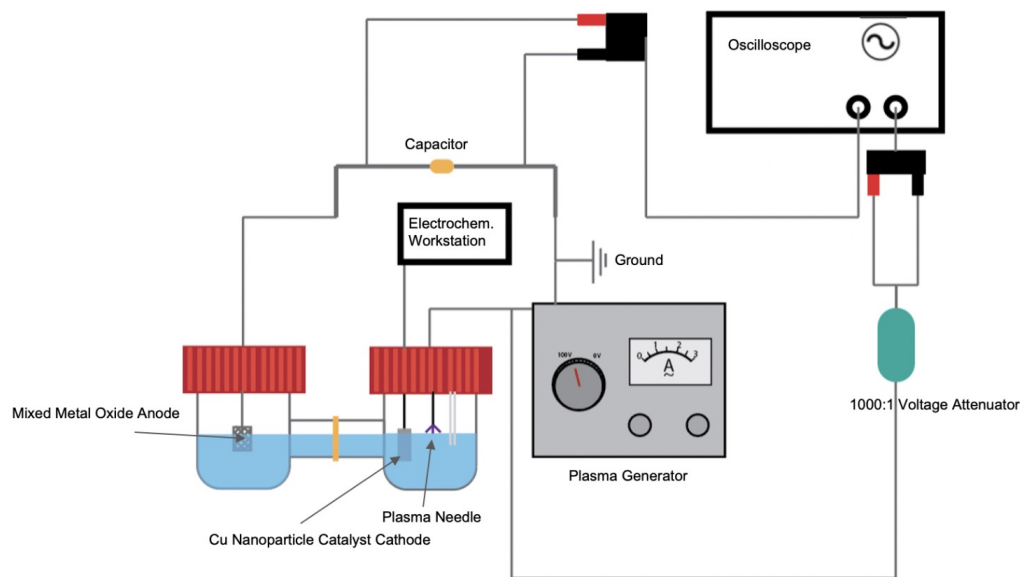

↑ Design of Plasma-Electrochemical Reactor over aqueous electrolyte

Plasma can be utilized as a pre-activation energy source to modify reaction pathways for chemical conversion processes. Applying a high voltage on the scale of 1 kV partially ionizes and excites gaseous species while maintaining overall reaction conditions at non-thermal and atmospheric pressure conditions. These excited species take part in unique reaction pathways, either directly in the conversion reaction or synergistically with catalyst surfaces, to promote fixation via complex electron transfer reactions. This project studied  $N_2$  and  $CO_2$  plasmas, motivated by the difficulty in converting these gasses to more reduced forms unless under high-pressure and high-temperature conditions. I investigated plasma reactors that convert  $N_2$  species into nitrogen fertilizers in aqueous irrigation streams with the aim of determining the energy efficiency and conversion capacity of the reactors. Next, I designed and characterized reactions using a novel H-Cell plasma electro-chemical reactor design, which excites  $CO_2$  species over a Cu nanoparticle catalyst to promote the production of formate, acetic acid, and ethanol. The presence of plasma shifted the production of ethanol: formate to 1:04:1 (versus the electrochemical case of 0.4:1).

Plasma-Electrochemical and Electrochemical experimental trials conducted at similar potentials, altering the ratio of ethanol production that occurs at the expense of formate production →

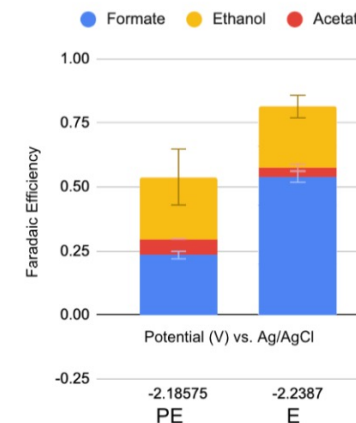



# Evaluating Methane Emissions and Mitigation Strategies on Small- and Mid-Sized Dairy Farms

**Alexandra Griffith '23**

Benjamin Franklin | Environmental Engineering

## Barriers to enteric methane interventions on mid-sized farms

Limited time/resources to evaluate intervention strategies

Explicit and implicit costs of altering “business as usual”

Complexity of carbon market participation

Example tier 2 model output values of annual methane emissions for grazing, pasture, and feedlot feeding situations for different herd sizes. For these values, herds are assumed to be composed of only lactating cows. →

Methane emissions from enteric fermentation and manure management. In 2020, dairy cattle operations emitted 31.7 million  $\text{MTCO}_2\text{e}$  of methane from manure management and 43.6 million  $\text{MTCO}_2\text{e}$  of methane from enteric fermentation. Although methane has a relatively low atmospheric lifetime, it has a high global warming potential. Most agricultural methane mitigation projects are being completed by Concentrated Animal Feeding Operations (CAFOs). While methane-reducing strategies have a high potential to reduce emissions from small and mid-sized dairy farms, several economic and informational barriers exist for farm owners to evaluate, consider, and implement existing methane mitigating practices.

OBJECTIVE: To build an easy-to-use MATLAB tool for farm owners that approximates farm-level annual methane emissions, suggests mitigation strategies, and estimates costs of suggested strategies.

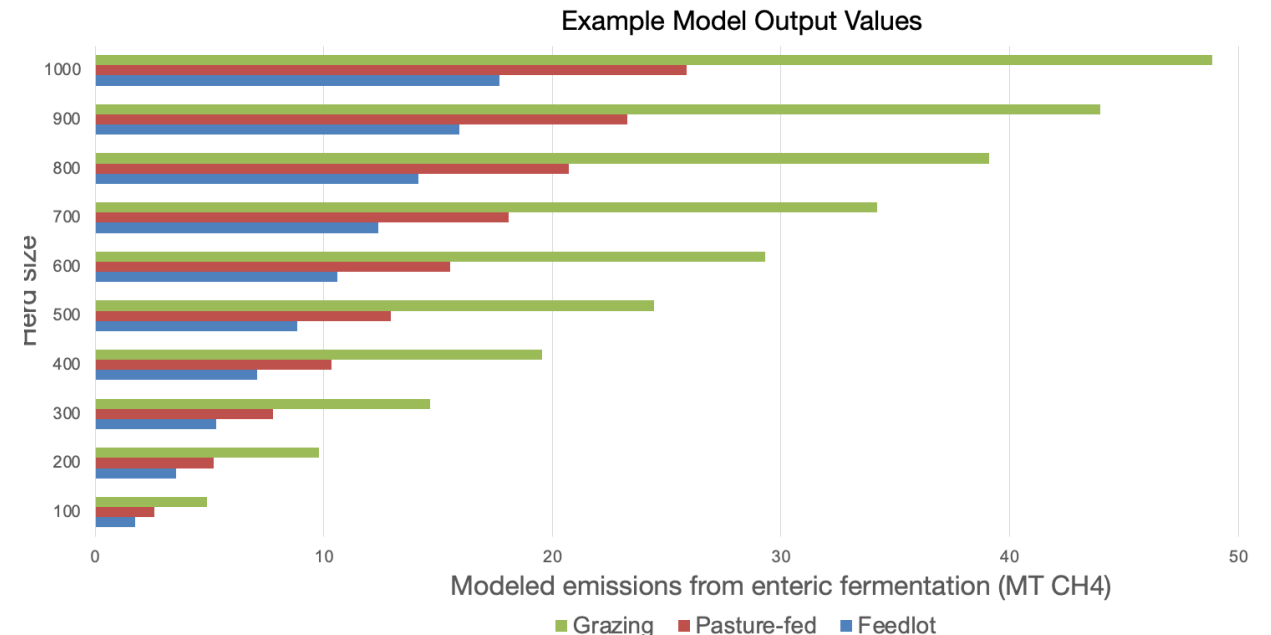



# Emily's Electric Adventure: Crafting a Kid's Book About Electrification and Climate Change

Iszak Henig '23

Davenport | Earth & Planetary Sciences

## Outline

- |   |  |  |  |
|---|--|--|--|
| <b>01</b><br><b>Significance</b><br>Background & Motivation | <b>02</b><br><b>Science</b><br>Climate Science and Childhood Education | <b>03</b><br><b>Story</b><br>The fun stuff | <b>04</b><br><b>Steps</b><br>What's next |
|---|--|--|--|

## Storytime!

Emily, an aspiring scientist and Corre, an electric eel

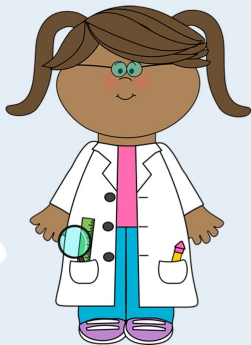

## Where?

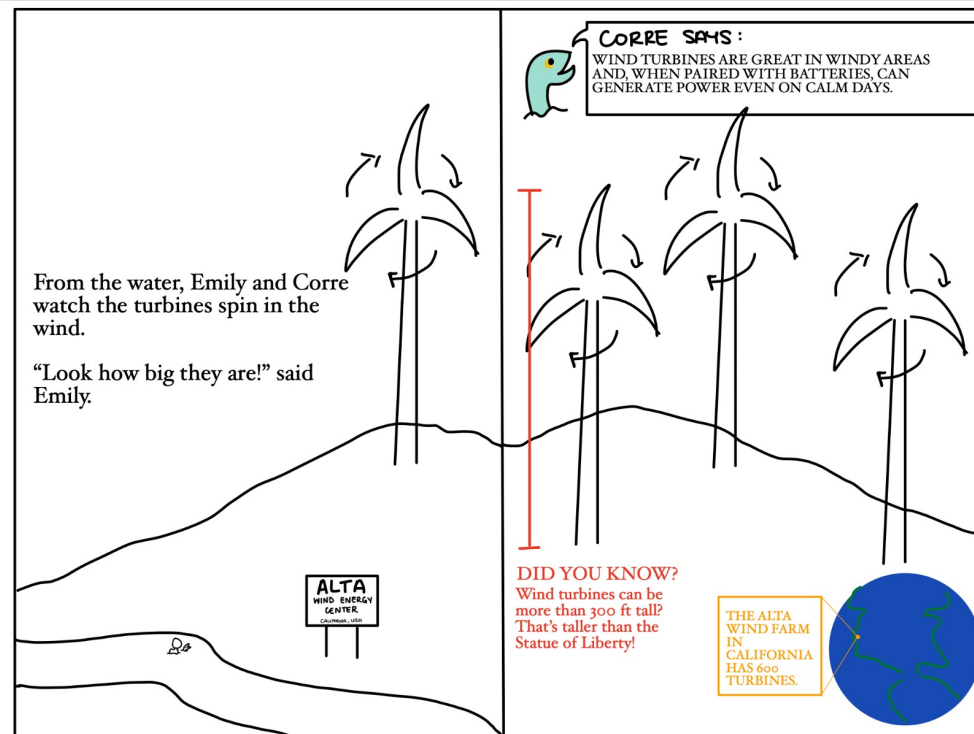



**Caitlin Henry '23**

Saybrook | Economics



## Cows and Climate Change

Making Cattle Even More Sustainable in the Face of Global Warming



**CLEAR Center**

Clarity and Leadership for Environmental Awareness and Research at UC Davis

*As the beef industry grows, it is becoming increasingly harmful to the environment and is escalating the climate crisis. Cattle production contributes to global warming primarily by producing methane and nitrous oxide. Other environmental externalities of beef production include carbon dioxide release from deforested land and pollution of local water sources from agricultural runoff. It is estimated that 20% of all greenhouse gas emissions come from animal agriculture and 14.5% come from livestock farming alone.<sup>1</sup> Modern day cattle farms are managed unsustainably, however, there are measures that can be taken to reduce the carbon footprint of livestock farming with limited economic impacts that should be integrated into agricultural regulation. Despite our growing population and our persistent demand for beef, especially in developing countries where beef is becoming more affordable, it is crucial that we transition to more sustainable livestock farming techniques, whether or not this may have unintended consequences on the beef industry.*

*This paper will evaluate the environmental impact of the beef industry, how it can be mitigated and the economic impact these mitigation techniques would have. ...*

*We can try and conceptualize the economic benefits and drawbacks of shifting beef production; however, it is very hard to precisely predict the impacts since the beef industry is so large in scale and its impacts trickle down into different sectors of the economy. That being said, the environmental need for this transition should overpower the potential economic and social drawbacks.*



# *The Future of Urban Agriculture and Hydroponics to Address Environmental Justice Issues*

**Brianna Jefferson '23**

Ezra Stiles | Environmental Studies

Tech At Bloomberg —

Share in

## **Technology Helps Grow Better Produce at Bowery Farming**

July 02, 2018



*This essay examines the use of hydroponics as a tool to address environmental justice issues. Minority and low-income communities in urban regions are disproportionately affected by food apartheid, and urban agriculture such as hydroponics are touted as a tool that may change the future of these communities. As an ethnographic study, companies of varying sizes in the Northeast and Florida were contacted to give their opinion on what their company was doing for the hydroponic industry, but also for social justice issues alike. The objective was to see whether environmental justice, specifically food security, was a core value of their mission statement and whether they were able to accomplish their goals.*

*I reached out to the companies Plenty, Bowery, and Gotham Greens, which are all based in boroughs in New York City. ... Analysis of the interview results found that there was a lack of willingness to divulge information about the hydroponic process. Additionally, at this time, it seems hard to gauge how productive these companies are in terms of actually creating solutions for food apartheid. Hydroponics seems more socially constructive rather than environmentally beneficial for struggling communities. ...*

*If hydroponic companies keep employing low-income and minority members of communities, then they will help those with food insecurity by giving them the monetary freedom to buy healthy food. There is no reason that a hydroponic company could not install themselves in a low-income community and locally source goods to that town. There need to be people behind these hydroponic companies that make this a priority....*



# Regional Analysis of Excess Power Available in 11 Selected Locations across the United States

**Katerina Kargioti '23**

Pauli Murray | Applied Physics

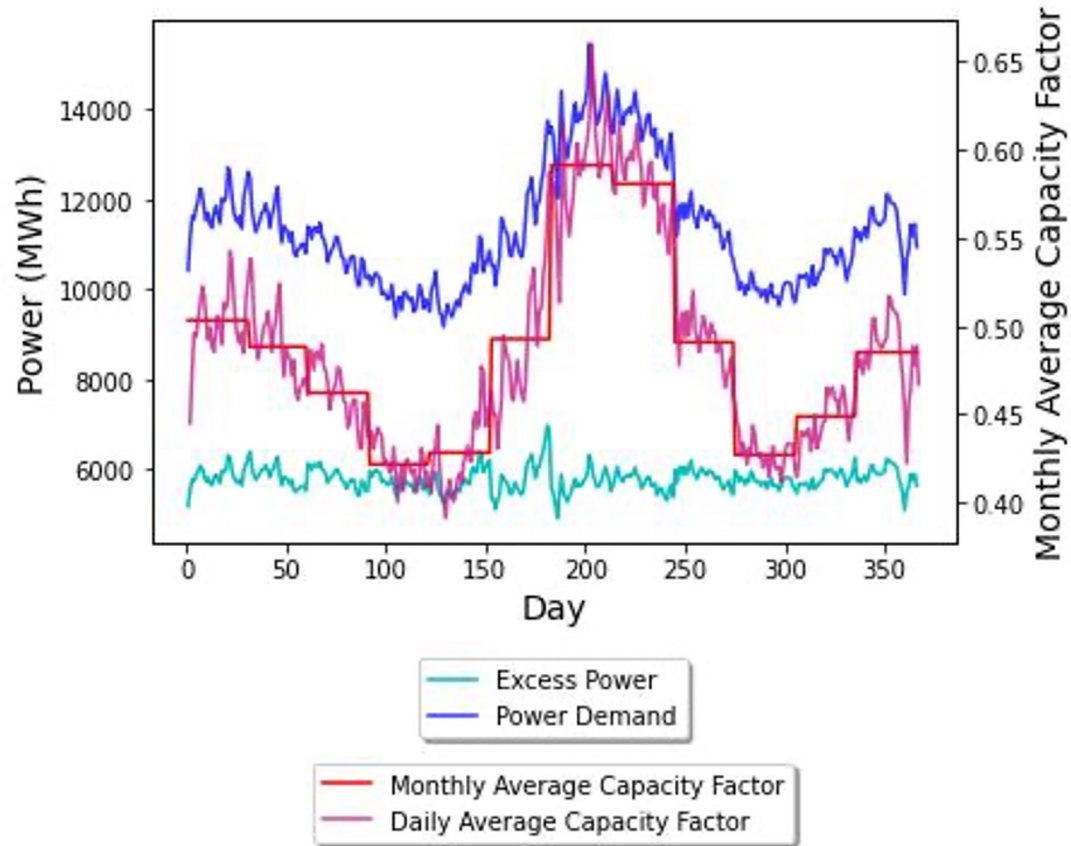

↑ The monthly average capacity factor has the form of a step function but displays the same overall trend with the daily average capacity factor (with a primary and two secondary peaks). Excess power is relatively stable.

Today I will present a continuation of my energy studies capstone project on a regional analysis of the excess power available in 11 selected locations across the United States, including power grids in New England, North and South Carolina, Texas, California, Florida, New York, Idaho, Montana, New Mexico, Oregon, and the Mid-Atlantic States.

This project is particularly important because of the ever-growing need for EV charging infrastructure. This increased need for EV charging stations makes it imperative to determine the excess power available at the grid. This important to decide to what extent and where EV charging stations can be installed. An additional factor we must consider in as we build charging stations is whether the excess energy comes from renewable or non-renewable sources to see if switching to EV in that location might provide additional benefits in terms of emissions reductions.

The two-part analysis performed consisted of the following steps. First, I averaged the data for each day to create an average daily power demand data frame. Then I performed a capacity factor analysis. To evaluate the sensitivity of the capacity factor, and, by extension, of our estimation of the excess power available to the grid, to fluctuations of the power demand (which could happen due to unexpected events like extreme weather conditions) I used to methods for calculating the capacity factor. One method was calculating the Daily Capacity Factor for a Selected BA and the other was calculating the Monthly Capacity Factor. ...

Daily capacity factors in the locations analyzed were about 50%, showing that a lot of] excess power is available in the grid.



# Harnessing a Hurricane's Energy in a Warming Climate

**Emma Levin '23**

Benjamin Franklin | Applied Mathematics

Challenergy's Magnus Vertical Axis Wind Turbine (Japan) could withstand 2021 Typhoon Kiko →



Ocean Power Technologies, says the company's PB3 PowerBuoys have the ability to continuously generate power from ocean wave energy. The buoy continued to provide power and operate fully during Hurricane Irene (2011) →



Hurricanes are natural disasters that expend an incredible amount of energy and have major socioeconomic implications. This presentation discusses the impacts of anthropogenic climate change on hurricane intensity, frequency, and track locations. It will also summarize contemporary efforts to convert a hurricane's energy into a green, usable form.

Although storms are projected to increase in intensity in a warmer climate, one fascinating result is that the overall number of tropical cyclones is projected to decrease globally. You can see these results in the figure on this slide, where in most basins there is a clear pattern of decreasing hurricane frequency over time as our climate has warmed. There is still some uncertainty about these results in the Atlantic basin, but in pretty much every other ocean basin, storms are projected to decrease in frequency. The past few slides reveal that hurricanes will become more infrequent, but the hurricanes we see will be incredibly powerful and yield a lot of precipitation.

The first effort is the Magnus Vertical Axis Wind turbine, created by the Japanese company Challenergy... [Another is] Ocean Power Technologies PB3 PowerBuoy which can generate energy from ocean waves and can withstand the treacherous ocean conditions inflicted by hurricanes

In summary, as our climate continues to change, hurricanes are projected to become more infrequent, more powerful, and shift towards uncharted territory.... Many creative individuals are hoping to capture some of the energy from a storm in a clean manner. There are efforts in industry and in academia that are making large strides in developing new energy storage devices.



# *Nuclear Fusion: The Potential Silver Bullet to Our Climate Issue*

**Evan Lipton '23**

Silliman | Engineering Science-Mechanical;  
Statistics and Data Science

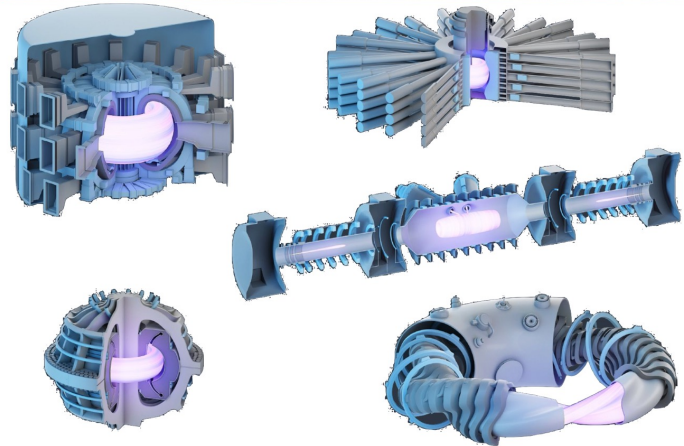
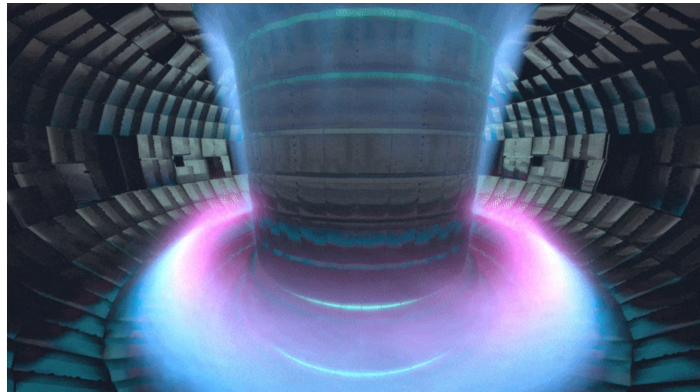

↑ Conceptual designs for controlled nuclear fusions reactors

*While we all know the we are currently facing a climate crisis, I felt like it was necessary to mention this to frame why I believe fusion will be achieved relatively soon. Our climate is warming due to the increase in fossil fuel usage and carbon dioxide emissions via the greenhouse effect... .*

*One potential option [for large-scale low carbon energy] is nuclear fusion. While fission, already used in today's nuclear reactors, is the breaking apart of large atoms into smaller atoms, creating a chain reaction, fusion is the binding of smaller atoms to create larger ones. This process is the most abundant energy source in the universe and is what created our planet and everything we know. It is what gives the sun and stars energy...*

*There are now 23 companies around the world working on 16 different configurations within the two main approaches to achieving nuclear fusion in a controlled reaction: inertial and magnetic confinement... The sector seems primed for rapid advancement as capital is invested, the approaches are growing and the amount of research is exponentially increasing.*

*We are at a tipping point with a positive feedback loop developing where increased funding leads to increased research and more progress and further capital investment.*

*Many of these companies plan to demonstrate fusion within 5 years, so with the amount of research being conducted and capital resources available, the chances that at least one player realizes this goal or more likely than previously expected.*



# Changing the Way the World Is Built: Rebar Placement in 3D Printing of Concrete

## Charlie Loitman '23

Silliman | Mechanical Engineering; Economics

*L.C. Lichty and E.O. Waters Prize in Mechanical Engineering,  
awarded to a senior for high scholarship and original research*

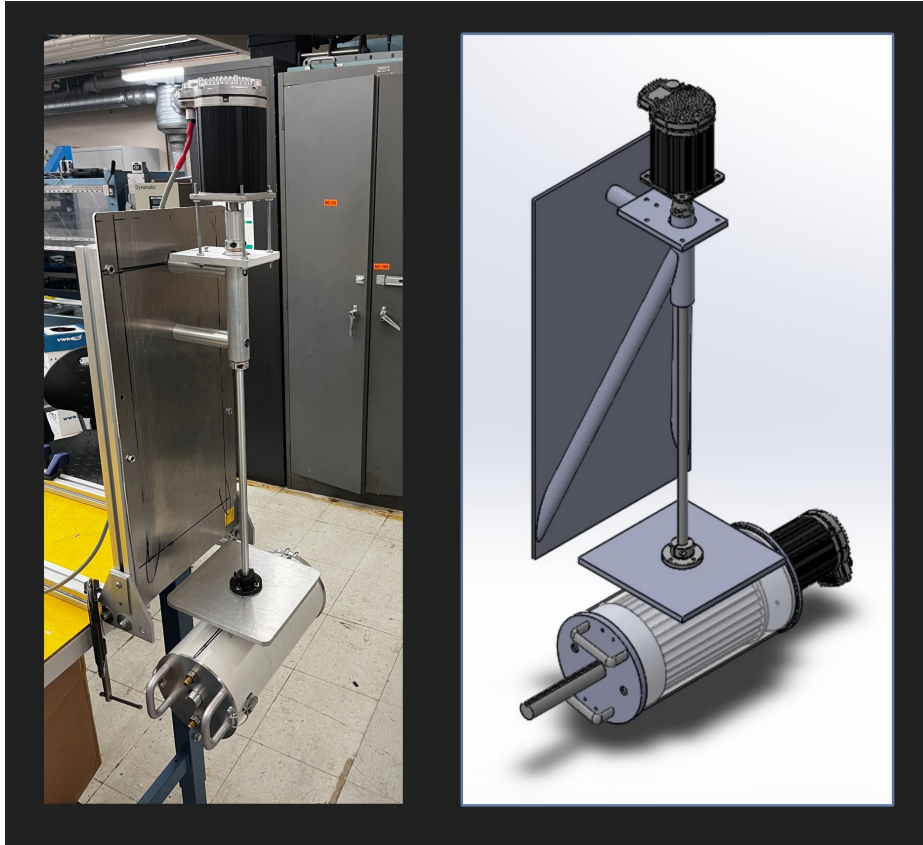

↑ Prototype rebar placement system    ↑ 3D rendering of the design

The problem that we are addressing is rebar placement while 3D-printing concrete structures. Currently, on-site technicians must manually place horizontal rebar on top of the print layers. While this presents little difficulty in the early stages of the print, it becomes hasslesome once the walls start getting higher and technicians have to use ladders to reach the top of the walls.

To address this problem, we need to develop a method that at least partially automates the process of placing horizontal rebar across the layers of 3D printed structures, with the goal of accurately placing the proper amount of rebar required throughout the print in whichever orientation is necessary.

This problem is important to solve because it streamlines the printing process as it reduces human input or interruption. The goal of this project is to cut human involvement in the rebar placement process by at least 50%. The more streamlined the process is, the easier and quicker it is to construct relatively inexpensive and sturdy homes. The primary stakeholders of this problem are on-site technicians and machine operators who proper rebar placement.

The goal is a design that can successfully place rebar along the print for one lap without having a technician intervene or interrupt the extrusion process.... Device should be easy to clean and be able to withstand a powerwash. Cost should be well below \$2,000.

Dispenser motor system →

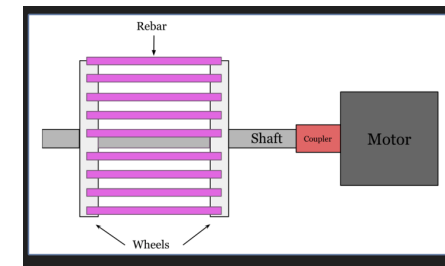



# Optimizing Demand Energy Response (DER): An Internship at the Company Voltus

**Anya Lomsadze '23**

Davenport | Statistics and Data Science

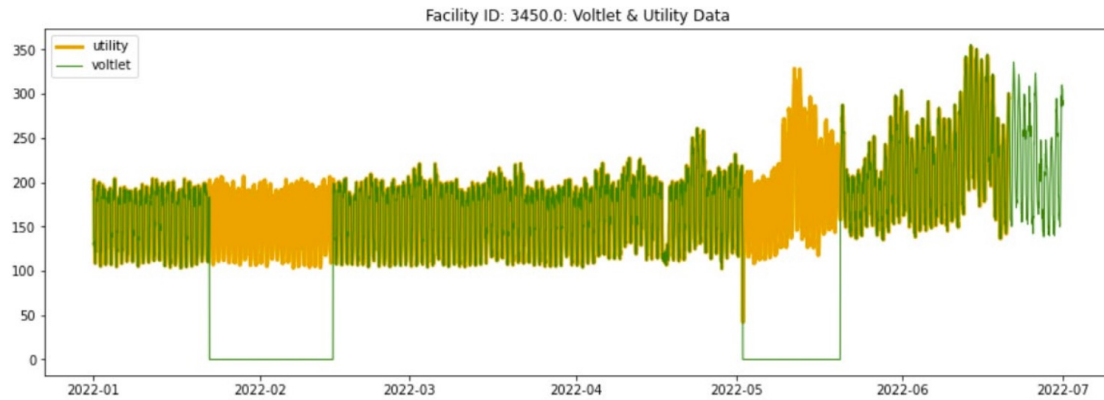

↑ Example of merged utility meter data with data from a system developed by the company Voltus which installs their own metering devices called *Voltlets*. These devices measure the same data as electricity meters managed by utilities, but they can provide data much more quickly to Voltus, meaning they can track performance live and pay out customers much sooner than if they only use utility data. One of goals of the project was to build a tool that automatically compares any pair of utility and Voltlet metering data from any utility and market.

*In this write-up, I will discuss my internship at Voltus, a company that connects distributed energy resources (DERs) to wholesale electricity markets in the United States and Canada. ....*

*DERs are physical and virtual assets deployed across the distribution grid, which can be used individually or in aggregate to provide value to the grid and its customers. DERs include everything from solar panels, batteries, energy efficiency upgrades, and demand management, all of which can be aggregated to provide services to the electric grid.*

*I worked on the engineering team at Voltus. Much of their work revolves around obtaining, managing, and validating electrical metering data. Demand response depends on being able to measure electricity usage and estimate the amount of energy that customers provided for the grid by responding to demand response dispatches. Managing this data is a challenge, to say the least – utilities vary hugely in how they provide data, in its frequency, and its quality.*

*This internship was an eye-opening experience in understanding how start-ups, utilities, power markets, and infrastructure operators interact. I learned how to solve an abstract data problem to create a concrete product that utilizes some of the oddities of metering data. I also learned about the software management cycle – much of the work I did...revolved around building API connections, testing code stability, and practicing safe data management protocols. I am very excited about the future of demand response and hopeful about the extent to which it can harness existing energy sinks and DERs to balance and stabilize the electrical grid. I believe this policy will play a leading role in the future of the grid.*



# Optimality of Thermal Energy Storage for Nuclear Power

Neal Ma '23

Silliman | Physics (Intensive)

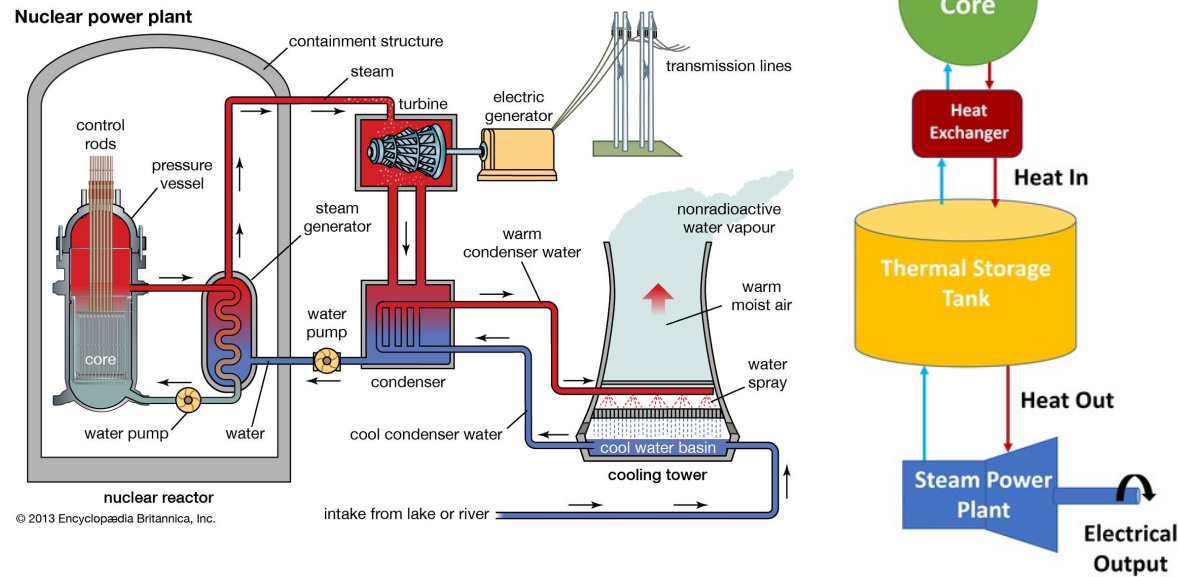

↑ (LEFT) Conventional pressured nuclear reactor with water as the working fluid circulating in a loop that exchanges heat with the nuclear core.

(RIGHT) Integration of nuclear reactor with thermal energy storage to provide a reservoir of heat available on demand.

Hello everyone! I am Neal Ma, a senior studying Physics and Computer Science, and today I will be presenting on the optimality of thermal energy storage for nuclear power.

The primary issue with using nuclear power for a significant portion of the grid, is the ramp-up, or response, time of nuclear power plants. Currently, nuclear power plants require over half a day to generate at full capacity from fully cold shut down. This leads to nuclear power typically being a baseload power source, or a power source that provides a constant amount of energy over time and does not vary greatly. While this is good for grid stability and ensuring that the minimum energy demand is met, we know that energy demand is not constant throughout the day.

Thermal energy storage, or TES, uses some sort of thermal energy bank to store energy as some heated material... There seems to be a very natural connection to how conventional nuclear power operates currently and how it could be integrated with thermal energy storage. Instead of the fission or fusion reactions heating up water that is used directly in the heat exchange, this could be replaced by some sort of thermal energy storage material such as molten salt, [which] could be retained in the molten salt and used later if a greater demand for the energy arises.

I hope that two things are abundantly clear: that nuclear power is a heavily under-utilized carbon-free energy source that has great potential to move the clean energy transition along, and that thermal energy storage is the optimum energy storage method for nuclear power plants. Thank you so much for your time and attention and if there is time, I would love to answer any questions!



# Reduce, Reuse, Reprocess: An Overview of Medical Device Reprocessing and Potential for Future Analysis

**Eliza Poggi '23 B.S./M.S.**

Saybrook | Earth & Planetary Sciences

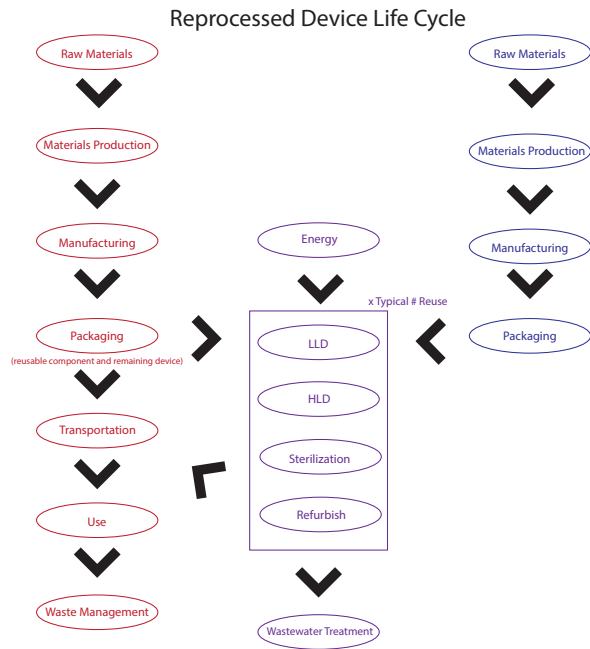

← A typical life cycle of a reprocessed medical device. Each step represents a different emissions profile that is dependent on industry standards, local regulations, hospital policies, and the nature of the device itself. LLD: low-level disinfection; HLD: high-level disinfection.

A common reusable medical device →

The American healthcare sector is one of the world's greatest emitters of greenhouse gases (GHGs), which contribute to climate change and quantifiable associated risk of illness and death. However, unlike other polluters, the healthcare sector has a unique mission to minimize adverse health outcomes. Enter: reprocessing, an alternative to disposal of single-use devices that involves a rigorous sanitation, disinfection, and sterilization process to allow the re-use of medical devices and can potentially lower GHG emissions.

Selected literature in the field of reprocessing is discussed, with an emphasis on studies that quantify changes to total GHG emissions for reprocessed medical devices using life cycle assessment. Then, a preliminary design for a simple emissions calculator for reprocessed devices is introduced before avenues for further improvement of the calculator itself and the reprocessing landscape as a whole are suggested. Overall, it is concluded that the implementation of reprocessing in medical settings is an urgent matter, but more scholarship must be done to quantify the benefits, which will be needed to encourage action by local and federal regulators.





# *The Marginal Impact of the African Development Bank's Energy Supply and Infrastructure Funding on Electricity Access*

**Abdoulie Sarr '23**

Benjamin Franklin | Engineering Science-Chemical; Economics

Variable	Mean	St. Dev.	Median	Min	Max	Units
Total Electricity Access	41.012	29.505	35.095	0.534	100.000	% of population
Rural Electricity Access	29.158	31.521	16.676	0.523	100.000	% of population
Urban Electricity Access	65.470	24.889	68.340	3.430	100.000	% of population
Energy Supply Disbursement per Capita	0.607	3.531	0.000	0.000	69.305	UA
Infrastructure Disbursement per Capita	2.421	10.451	0.000	0.000	172.696	UA
GDP per Capita	1,915.706	2,650.934	848.019	110.461	19,849.720	Current US\$
GDP per Capita Annual Growth	1.482	4.970	1.801	-48.392	55.590	Annual %
Population Density	89.434	117.892	49.837	1.775	623.517	People per sq. km of land area
Net Development Aid per Capita	63.591	67.397	46.250	-11.967	691.925	Current US\$

↑ Summary statistics of 53 African countries from years 1990 to 2020, which form the working data set for this study, a total 1265 observations in this date range.

The frequent power outages in my home country of The Gambia sparked my interest in electricity and energy infrastructure. Electrification, energy policy, and power sector infrastructure are at the forefront of development policy in Africa. Currently Over 640 million people do not have access to energy and by 2025, 25% of the globe will reside on the continent. Needless to say, the United Nations Sustainable Development Goal (SDG) 7—Securing affordable, reliable and sustainable energy for all by 2030—will go as far as Africa goes.

As the lead source of development financing for its 54 regional member countries, The African Development Bank has an invaluable role in driving electrification. In this paper, I pose the question of whether the African Development Bank's loan and grant disbursements in infrastructure and energy supply have been effective in driving access to electricity relative to controls such as GDP growth and official development aid and assistance over the last 20-30 years.

I use a two-ways, fixed-effects ordinary least squares (OLS) regression on lagged disbursements with robust standard errors. The data is an unbalanced panel of 53 countries from 1990-2020. The results are that African Development Bank energy supply, and not infrastructure, disbursements have had a larger positive impact on electrification than development aid and GDP growth, particularly for countries with low access. For more electrified countries, energy supply disbursements are less significant than aid or economic growth in driving electrification at the margin.



# Intragenerational Equity in the Social Cost of Carbon

## Naomi Shimberg '23

Ezra Stiles | Ethics, Politics, and Economics

*Wrexham Prize for the Best Senior Essay in the Social Sciences*

*Emphasizing the Links Between Political and Economic Ideas*

	Model	Specification	Mean SCC	Incremental change (\$ per tCO <sub>2</sub> )	Share of total change to preferred (%)
1	DICE-2016R	3% near-term discount rate Consumption discounting	44		
2	GIVE DICE damage function	3% near-term discount rate Consumption discounting	59	15	4
3	GIVE Cromar et al. (2022)	Country-level VSL 3% near-term discount rate Consumption discounting	80	21	6
4	GIVE Cromar et al. (2022)	Country-level VSL 2% near-term discount rate Consumption discounting	185	105	31
5	GIVE Cromar et al. (2022)	Country-level VSL 2% near-term discount rate Income discounting	180	-5	-1
6	GIVE Bressler et al. (2021)	Country-level VSL 2% near-term discount rate Income discounting	231	51	15
7	GIVE Bressler et al. (2021) <b>(preferred)</b>	Global average VSL 2% near-term discount rate Income discounting	380	149	44
8	GIVE Bressler et al. (2021)	Equity weighting 2% near-term discount rate Income discounting	504	124	

↑ Evolution of mean SCC from DICE-2016R to this study. All SCC values are expressed in 2020 US dollars per metric ton of CO<sub>2</sub> and represent the mean value from 10,000 Monte Carlo simulations. Row 1 shows the mean SCC of \$44 estimated using the DICE 2016R deterministic model. This value is comparable to the value previously estimated by IWG DICE-2010 of \$46 as well as the most commonly cited.

The social cost of carbon (SCC) reflects a partial estimate of the monetary damages caused by an incremental metric ton of CO<sub>2</sub> emissions. The Environmental Protection Agency (EPA) recently released a long-awaited update to the SCC, increasing its preferred value from \$51 per tCO<sub>2</sub> to \$190 per tCO<sub>2</sub>. This is the first time the mortality impacts of climate change have been included in the SCC, reviving contentious debates about whether to monetize mortality risk with a value of a statistical life (VSL) that varies with income or remains constant across the population. The EPA diverges from past practice and uses an income-elastic VSL in its updated SCC, therefore assigning greater value to statistical lives in high-income countries than low-income countries.

This senior essay proposes two alternative approaches, both of which assign equal value to all statistical lives: (1) using a global average VSL as an extension of past practice and (2) equity weighting—assigning greater weight to dollars in lower-income individuals' hands. I ultimately defend the use of a global average VSL on ethical, economic, and practical grounds. I then implement each approach in the new open-source Greenhouse Gas Impact Value Estimator (GIVE) model, one of three models used by the EPA in its updated estimate. My preferred mean SCC is \$380 per tCO<sub>2</sub> (\$10-\$998 per tCO<sub>2</sub>: 5%-95% range, 2020 US dollars), double the EPA's proposed value. If used in benefit-cost analysis, this SCC would substantially increase the estimated benefits of climate change mitigation by reflecting that the harms of climate change are not borne equally across society.



# Creating Sustainable Buildings: An Internship at Arup

## Wyatt Sluga '23

Trumbull | Mechanical Engineering



↑ Interns on a site visit at Arup's office in Washington, D.C.

*My internship started in June, 2022 and I was located in the Washington, D.C. office, of Arup, an engineering firm employs engineers, consultants, and advisors that specialize in a sustainable future. Arup works in many disciplines including buildings, infrastructure, sustainability and the climate, digital, planning, and technical consulting.*

*My main purpose was to support the mechanical engineering team however I could. The details of my day-to-day work are outlined throughout this essay, as are the responsibilities that my job description listed.*

*In the office, I had my own desk and worked next to most of the other interns (although they tried to evenly space us throughout the full-time staff). Twice a week, the mechanical team would have meetings all together in a conference room. One of the meetings was a resourcing meeting every Tuesday in which we would all discuss our workload and projects so we could most effectively allocate team members to projects. The other was a check-in meeting later in the week to revisit what we had discussed in the resourcing meeting...*

*Perhaps my favorite part of the entire internship was a discipline that I spent minimal time in. Arup introduced me to energy modelling. Since my internship, I've been fascinated by the prospect of modeling an entire building's energy needs and use before the building has ever been constructed.*

*This interest led me to learn more about energy modeling through coursework at Yale. I created an independent project that would allow me to attempt to create an energy model of a Yale building.*



# Rocky River in 95% Renewable Future: Case Study Analysis for the Hydropower Collegiate Competition

## Katrina Starbird '23

Timothy Dwight | Earth & Planetary Sciences

Team Lead, Yale Hydropower Collegiate Competition Team, HCC 2023

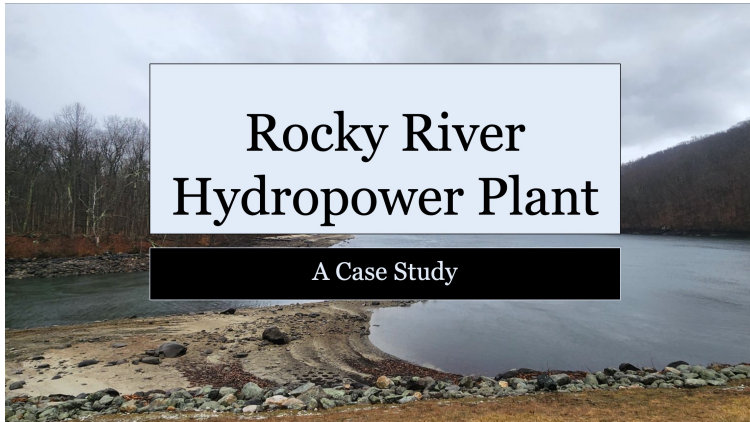

This case study considers possible operations for Rocky River Hydropower Plant in 2035. This year, we assume that the grid will be composed of 95% renewable energy. In such a situation, the operational strategy for hydropower, and in our case pumped storage hydropower, will change. To project the operations for this year, we consider the environmental, hydrologic, financial, and social parameters for Rocky River.

Rocky River Hydropower Plant was first created in 1929 in Milford, Connecticut and lies alongside the Housatonic River. Rocky River is the first pumped storage hydropower facility constructed in the United States. It pumps water from the Housatonic River into Candlewood Lake, an artificial lake located approximately 200 ft in elevation above the river. Candlewood Lake is bordered by many housing properties that use the lake for recreational purposes. Owned by FirstLight Power, Rocky River is operated in conjunction with three other dams owned by FirstLight on the Housatonic River.

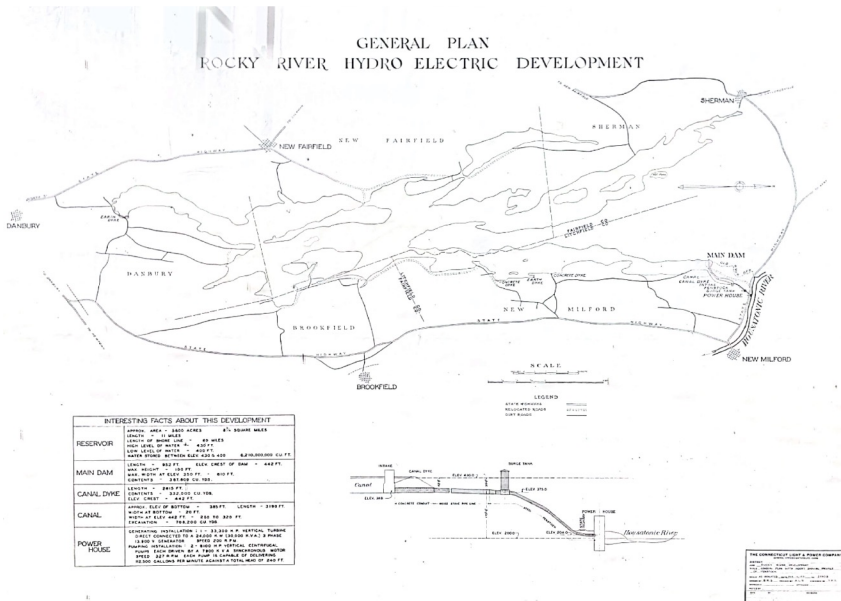

← Schematic from the original plan for development of the Rocky River Pumped Storage Hydroelectric Facility in New Milford, Connecticut, the first PSH plant in the U.S.

Prizes awarded to the Yale team at HCC 2023:  
Second Place: Overall HCC Competition;  
First Place: Creating Connections Challenge.  
Team consisted of Katrina Starbird (Team Lead), Shayaan Subzwari, Neal Ma, Maddie Bartels, Selin Goren, and Ruth Lee. →



# Rocky River in 95% Renewable Future: Case Study Analysis for the Hydropower Collegiate Competition

**Shayaan Subzwari '23**

Silliman | Physics (Intensive)

Howard L. Schultz Prize for Outstanding Seniors in Physics

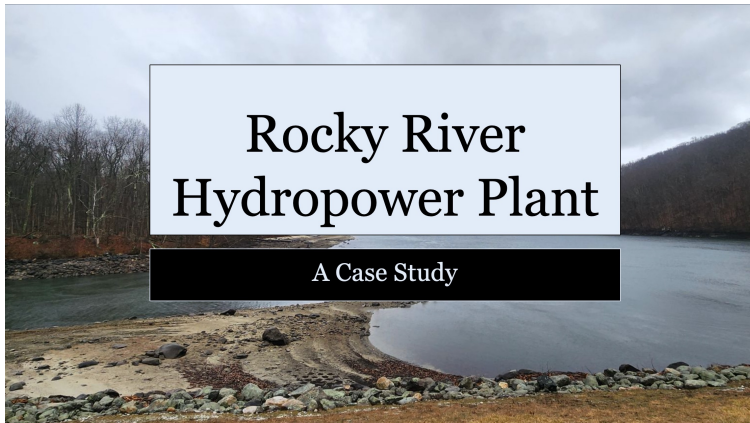

This case study considers possible operations for Rocky River Hydropower Plant in 2035. This year, we assume that the grid will be composed of 95% renewable energy. In such a situation, the operational strategy for hydropower, and in our case pumped storage hydropower, will change. To project the operations for this year, we consider the environmental, hydrologic, financial, and social parameters for Rocky River.

Rocky River Hydropower Plant was first created in 1929 in Milford, Connecticut and lies alongside the Housatonic River. Rocky River is the first pumped storage hydropower facility constructed in the United States. It pumps water from the Housatonic River into Candlewood Lake, an artificial lake located approximately 200 ft in elevation above the river. Candlewood Lake is bordered by many housing properties that use the lake for recreational purposes. Owned by FirstLight Power, Rocky River is operated in conjunction with three other dams owned by FirstLight on the Housatonic River.

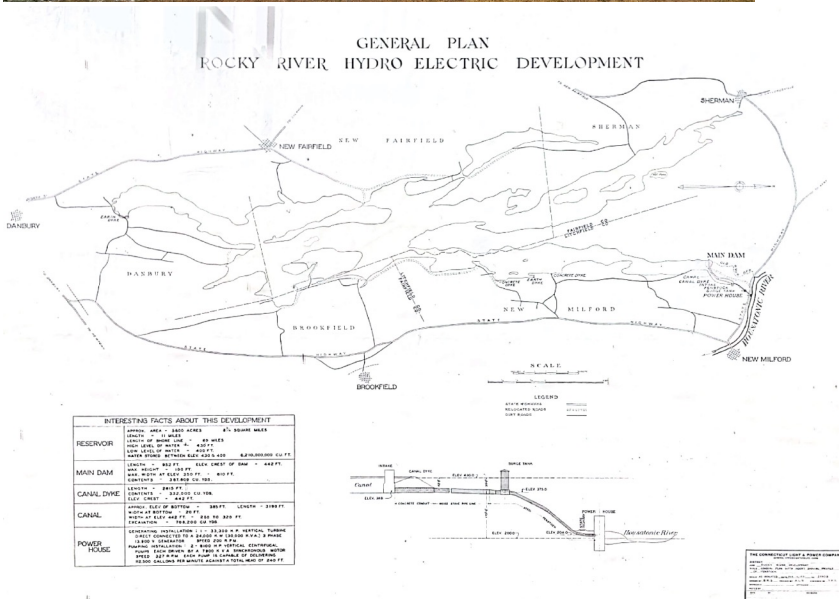

← Schematic from the original plan for development of the Rocky River Pumped Storage Hydroelectric Facility in New Milford, Connecticut, the first PSH plant in the U.S.

Prizes awarded to the Yale team at HCC 2023:  
Second Place: Overall HCC Competition;  
First Place: Creating Connections Challenge.  
Team consisted of Katrina Starbird (Team Lead),  
Shayaan Subzwari, Neal Ma, Maddie Bartels,  
Selin Goren, and Ruth Lee. →





# *A Summer in Renewable Energy Development: Where Is It Going? What Comes Next?*

## **Alex Surratt '23**

Pierson | Engineering Science-Mechanical; Economics

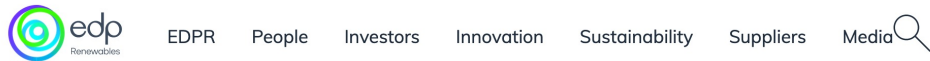

# We Choose Earth

Learn more about our strategy for 2023-2026. >

*This past summer I worked as a Project Development Intern for EDP Renewables, a renewable energy company that develops, owns, and operates renewable assets. I was in the Portland, OR office and supported the team in their prospecting, pipeline, and late-stage development of solar and wind assets across the western United States. Through this development work I gained valuable experience in the various stages of renewable energy development, got perspective on a variety of important issues facing the sector, and gained key insights on where the industry may be headed next. This opportunity also highlighted to me the importance of, and my desire to, work in the energy transition throughout my career which takes the form of working at a battery energy storage system company in New York City next year.*

*In this written report that will serve as my Energy Studies capstone project I will review some of the excitement in the renewable energy industry before giving an overview of the stages of renewable energy development and the variety of factors a developer considers as they identify, plan, evaluate, permit, and execute on a project. Then, I will highlight a key issue I explored this summer around the availability of suitable land and the opportunities that lie in federal land development for the industry at large. ...*

*Through my summer internship in renewable energy and through this energy studies program at Yale I have learned about a wide variety of technologies, policies, and issues effecting the growth of renewable energy today and the important roles I can fill to support the industry into the future.*

# Marine Dolphin Enterprises and Hydrogen's Potential in Aviation

## Samuel Thompson '23

Jonathan Edwards | Economics



Hi everyone. Thank you for coming to my senior capstone presentation. Today I will discuss my internship experience with Marine Dolphin Enterprises and the potential to use hydrogen in the aviation industry.

I worked with Marine Dolphin during the summer of my sophomore year at Yale. My boss and the founder of Marine Dolphin came across Marine Dolphin's core technology and was interested in developing it further.

As an intern, I helped to analyze the technology Marine Dolphin needed to license, reach out to obtain the license, draft the business plan for Marine Dolphin, and helped with a host of other related tasks. Later on in the internship, I found and made the initial connections with a scientist and engineer who are now the Chief Science Officer and Chief Operations Officer of Marine Dolphin, respectively. It was very exciting and rewarding to be there for the inception of Marine Dolphin and work to build the initial team and plan for the company.

My conclusions were that regional airports with defined regional flight paths have a greater potential to implement hydrogen aircraft and systems in the near future. Marine Dolphin has the ability to develop its technology and become a leader in seawater electrolysis. The main obstacles it will face will likely be in building its proof of concept efficiently and deploying its technology at scale if the concept is proven. The most likely scenarios for success would be receiving substantial funding from the US government or being acquired by a larger player in the energy industry who could offer the resources and funding to deploy the technology at scale.

<sup>1</sup> Hydrogen compared with other zero- to low-emissions energy sources



# Enhanced Weathering as a Negative Emissions Technology for Application in Wastewater Treatment Plants

**Aimee Titcher '23**

Grace Hopper | Environmental Engineering

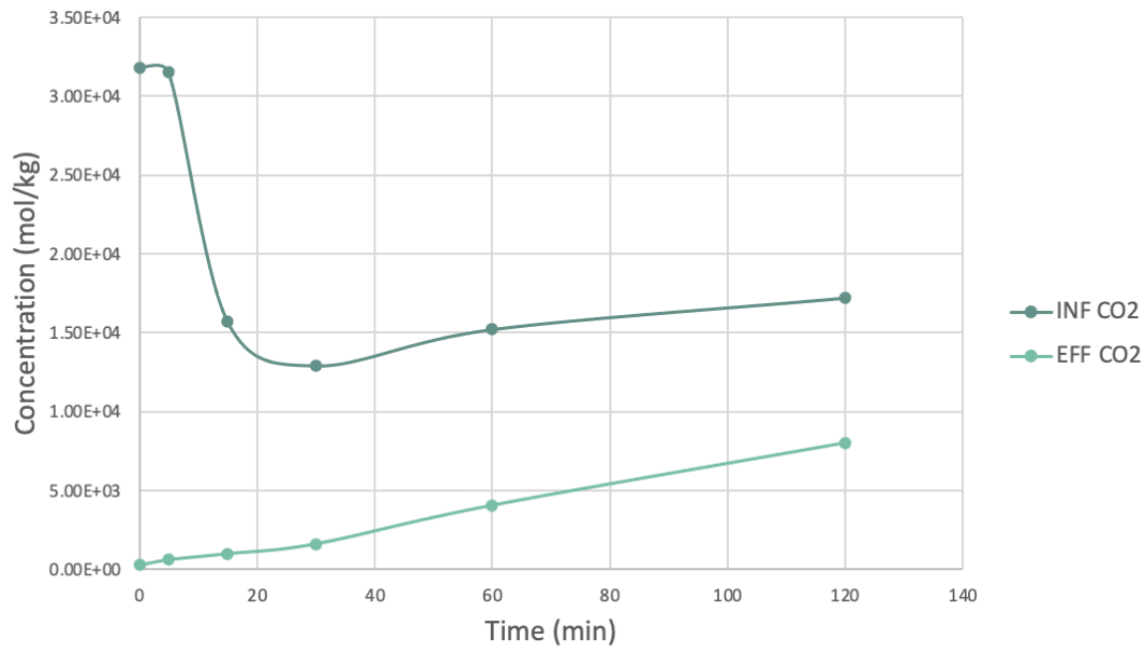

↑ Experiment with full prototype. Graph shows the difference between the CO<sub>2</sub> concentrations in the influent and effluent waters, demonstrating that the CO<sub>2</sub> concentrations are always higher in the influent waters than in the effluent waters, meaning that at some point throughout the experiment and within the full prototype system, the CO<sub>2</sub> concentrations were decreased.

Enhanced weathering as a method for natural carbon capture was the focus of an internship which I completed with the Yale Carbon Containment Lab (CCL) during the summer of 2022. Enhanced weathering is the process by which carbon dioxide is captured from the atmosphere and stored for long time scales through the dissolution of silicate or carbonate minerals (Renforth, 2012). This long-term storage of carbon comes in the form of the bicarbonate ion (HCO<sub>3</sub><sup>-</sup>) which can be produced through the following reactions between CO<sub>2</sub> and limestone and CO<sub>2</sub> and olivine, the two reactions studied during this internship (Bach et al., 2019):

CO<sub>2</sub> and Limestone:



CO<sub>2</sub> and Olivine:

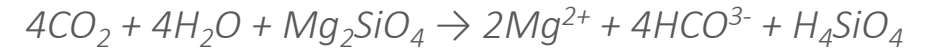

Although both limestone and olivine are able to facilitate the capture and long-term storage of carbon dioxide, there are pros and cons to using one over the other in an enhanced weathering system. ...

The high presence of carbon in the form of bicarbonate upon completion of these experiments prove that the tested systems represent promising methods for capturing carbon dioxide. Future research into ways to perfect the design of the full prototype before actual implementation by limiting outgassing of CO<sub>2</sub> and maximizing the surface area of limestone that is in contact with water is currently being conducted. Overall, the tests run on this technology prove that these methods have the potential to work upon implementation, providing a promising hope for an enhanced weathering step during wastewater treatment to generate negative CO<sub>2</sub> emissions.

# Thermal analysis of the Solar Enclosure for Water Reuse Water Disinfection System

**Gavrielle Weibel '23**

Pauli Murray | Engineering Science-Mechanical;  
Earth & Planetary Sciences

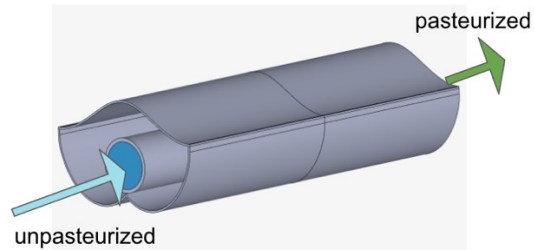

↑ Three-dimensional rendering of one SEWR reflector (US Patent, 2012). Model by Mandi Pretorius using SolidWorks computer aided design. Cold water flows in, heats up, and by the time it exits the enclosure, it is pasteurized and ready for use. Reflectors lie such that water tubes are parallel to one another within a roof or window.

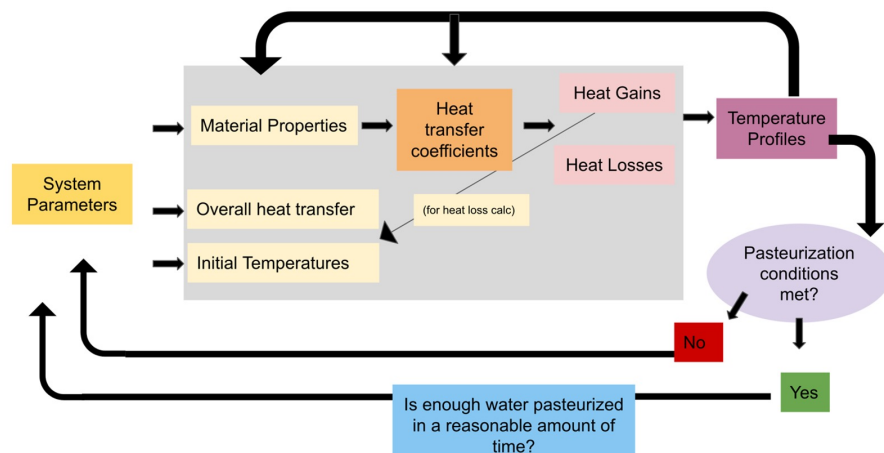

↑ Flow chart of model with components of the heat transfer model within the gray box

A solar water pasteurization system is being designed for a home in Solola, Guatemala in order to provide clean drinking water to household residents who would not otherwise have access. The design of this home relies on modular systems that utilize natural resources to meet household energy, water, and food needs. The Solar Enclosure for Water Reuse (SEWR) is a patented design for water disinfection that utilizes solar energy to heat up and disinfect water.

The aim of this project is to develop a steady state heat transfer model of one reflector within a SEWR system, given constant solar heat flux and constant water flow rate. The model provides information on heat gain, heat loss, and resulting temperature gradients across the reflector, radially and longitudinally. No significant heat loss was found, indicating effective insulation of the flowing water. The model is used to evaluate how system parameters, particularly water flow rate and water flow path length, impact the system's capacity to disinfect water for household use.

At flow rates below 18 ml/min, up to 84 liters of water can be pasteurized in one roof system in 6 hours of full sun. At faster flow rates, the water must be recirculated through the reflector multiple times. Next steps involve validating and fine-tuning the model with real-world experimental data. Then, this single-reflector steady-state model will be integrated into a whole system design. Multiple possible designs will be compared to evaluate the most effective way to supply clean water to household residents throughout a given day, and throughout the year.



# To Ski or Not to Ski: The Present and Future of Ski Resort Emissions

**Patrick Yang '23**

Saybrook College | Economics

Ski resorts are melting. Here's what that means for winter vacations

Rob Hodgetts, CNN  
Published 7:13 AM EST, Sat December 10, 2022



Raymond Roig/AFP/Getty Images

Can Skiing Survive Climate Change?

April 15, 2022 · 12:16 AM ET

By Kirk Siegler, Aaron Scott

 13-Minute Listen

+ PLAYLIST



Ski resorts are dying. Even as interest in skiing grows after the COVID-19 pandemic, the number of challenges facing ski resort operators grow at an even faster rate. **While some of these challenges can be attributed to rising housing prices in ski towns or a shortage of labor, climate change is the largest threat to the skiing's existence.** Low snow totals and warm temperatures can derail a resort's entire year [Siegler, 2022]. Because of their seasonal nature, ski resorts rely on revenues from just a few weeks of customers during holiday periods to support year-long operations. Climate change has destroyed this traditional model and forced independent ski resorts to join larger "mega passes" in an effort to guarantee annual revenue. At the same time, however, ski resorts are large contributors to global—and especially local—emissions.

Ski resorts require immense amounts of electricity to operate snowmaking equipment and ski lifts. Snowcats use hundreds of gallons of diesel every night for grooming operations. These are just some examples of the direct operating emissions associated with ski resorts. The indirect emissions are perhaps even greater. Millions of customers travel hundreds of millions of miles to visit rural, high-elevation ski towns. **Ski resorts are not an inherently sustainable operation. That does not mean that ski resorts are not trying to become more sustainable.** Many resorts publish sustainability goals and some have even switched to 100% renewable energy sources. Unfortunately, these areas are shining examples instead of the norm. Is the ski industry contributing to its own demise? This paper explores ski resort emissions in the United States, proposes potential solutions to reduce emissions, and presents a case study on sustainable skiing.

# Yale Energy Studies

SOCIETY • TECHNOLOGY • ENVIRONMENT

*Class of 2023 Yale Energy Scholars*

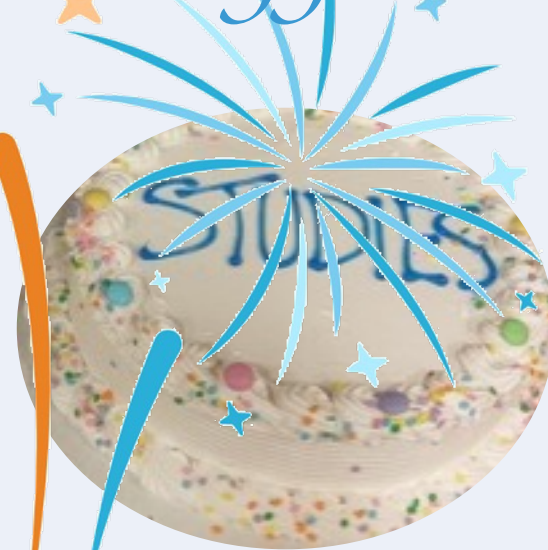





## Class of 2023 Yale Energy Scholars

30 Graduating with Energy Studies Certificates in May 2023  
(2 in the Class of 2023 delaying until the Fall or next Spring)

40 B.A./B.S. Degrees and 1 M.S. Degree in the Class of 2023 in 16 Different Majors

Applied Mathematics (1); Applied Physics (2); **Earth & Planetary Sciences (5)**; **Economics (9)**;  
Engineering Science-Chemical (2); **Engineering Science-Mechanical (6)**; Engineering Science-Electrical (1);  
Environmental Engineering (2); **Environmental Studies (3)**; Ethics, Politics, and Economics (1); Film and Media Studies (1);  
Global Affairs (1); Physics (Intensive) (2); Political Science (1); Statistics and Data Science (2); Urban Studies (1)

## To the Yale Energy Scholars in the Class of 2023

Every year when I go through your capstone projects to prepare this slideshow, I am surprised, amazed, and astonished by the diversity of topics, by the level of thought and detail, by the creativity, by the ENERGY that has gone into the work you do to think up, design, and execute these projects over the course of senior year, and in many cases longer than that.

Every year I go in thinking, "Surely last year was the best. This group is good, very good. But it's not possible to beat the work of last year's class. Equal maybe, but not be better." And so far, at least, every year I've been very wrong. (Of course, that's not what I'll tell the previous classes when they come back for reunions. But that's just between you and me for now.) You've all done outstanding work.

Still, I have to say that the slide I'm most eager to prepare each year is this one (previous slide). Look at what you've achieved as the 2023 Class of Yale Energy Scholars, outside of your capstones:

**30 Yale Energy Scholars in the Class of 2023**, with 2 more from the original Class of 2023 graduating in the Fall.

**40 B.A. or B.S. degrees** (which will grow to 44 in December, at least that's the plan), so obviously a bunch of double majors there.

**1 Combined B.S./M.S. degree**, in Earth & Planetary Sciences, a remarkable achievement.

**16 different majors represented:** ECON re-claimed top spot this year with 9 majors, but look at Engineering Science, which is tied at the top with 9 majors if you add up Mechanical, Chemical, and Electrical Engineering. Delighted to see EPS next with 5 majors and EVST with 3. But look at all the others: EP&E, Global Affairs, Physics, Applied Physics, Film and Media Studies (that's from a double major, Mechanical Engineering and Film Studies, what a combination!), Political Science, and Statistics and Data Science. Remarkable diversity!

Members from this year's class have won a bunch of department and university awards: I won't go through that list. You will hear about some of them at Class Day.

And I've already mentioned the team from Energy Studies which won 2 prizes at the first annual Hydropower Collegiate Competition sponsored by the National Renewable Energy Lab of the US Department of Energy—for a case study of Rocky River, a pumped storage hydroelectric power facility in Connecticut, the first such facility to be built in the US. In a few years, it will be 100 years old, and the team envisioned how it could continue to perform a useful function on the New England grid well into its second century, even through DOE had edited the facility out of its projections for the New England region in the 2030s!

**Congratulations to the team and to all of you.**

When you drink champagne, you must make a toast (that's something I learned working for many years in a French company). So:

*To the Yale Energy Scholars in the Class of 2023: May you never lack the energy to pursue your dreams.*

*And: May your dreams change the world. Hold on. Let me revise that: May your dreams change your world:*

*The people, places, and things that are near and dear to you. Because that's what counts.*

*To the Yale Energy Scholars in the Class of 2023. Cheers! (literally)*

— Michael Oristaglio, *Director Energy Studies*





*Yale Energy Scholars  
Class of 2023*



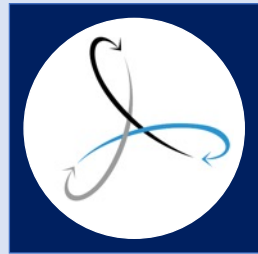

**Yale**

ENERGY STUDIES

*Multidisciplinary Academic Program*



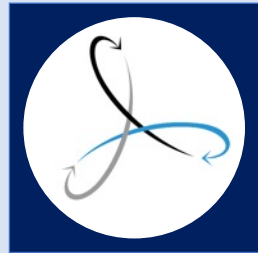

**Yale**

ENERGY STUDIES

*Interdisciplinary Certificate Program*